

2024

BUSINESS DIRECTORY



129TH ANNUAL EXPO

Augusta Civic Center, Maine

Includes Buyers Guide • Inspector Directory • Members & Suppliers
Key State Officials • Useful Charts & Graphs



F.W. WEBB COMPANY

The largest distributor of Plumbing, Heating, HVAC/R and PVF in the Northeast

Extensive selection from top manufacturers

Serving industrial, institutional, commercial and
residential contractors since 1866



Twelve locations in Maine, including:

Augusta
207-623-2521

Ellsworth
207-667-9322

Oakland
207-716-1456

West Bath
207-442-7990

Biddeford
207-282-7558

Hampden
207-947-6905

Rockland
207-594-6200

Windham
207-892-5504

Caribou
207-498-2526

Lewiston
207-784-4575

S. Portland
207-772-8364

Winslow
207-873-2111

Visit fwwebb.com for more information

2024 BUSINESS DIRECTORY

A Comprehensive Directory of the State of
Maine Plumbing-Heating-Cooling Contractors
and Related Businesses

www.maine-phcc.com

Presented by

Maine Association

Plumbing-Heating-Cooling Contractors

Portland, Maine 04103

(207) 829-5055

Fax (207) 829-5031

Published March 2024

MISSION STATEMENT

“The PHCC-National Association, of which Maine PHCC is a member, is an Association of plumbing, heating, and cooling contractors dedicated to the promotion, advancement, education, and training of the industry for the protection of the health, safety, and comfort of society and the protection of the environment.”

CODE OF ETHICS

- To consider our trade worthy as affording us distinct opportunities to serve society
- To improve ourselves, increase our efficiency and enlarge our service, and by so doing attest our faith in the fundamental principles of life, that we profit most who serve best
- To realize that we are businesspersons and ambitious to succeed; but that we are first ethical persons, and wish no success that is not founded on the highest justice and morality
- To maintain the highest ethical standards of advertising, pricing, selling, installation and service guided by the principles of honesty and integrity
- To promote the latest technological advances in the design, types and methods of installation of plumbing-heating-cooling systems; using equipment and materials complying with the standards recognized by this industry
- To enter enthusiastically into the association work—to give as well as take—and do our part in elevating the industry
- To support all progressive moves that are being carried out along the lines of trade extension, standardization and sanitation
- To conduct our affairs that others in our business will find it wise, profitable and conducive to happiness to emulate our example
- To follow and execute our work in conformity with federal, state, county and city building, safety, energy and water conservation, fire and housing codes; and refusing to be a party to any action that violates these regulations
- To promote conservation of water and energy to the public we serve through improved, adequate, safe, modern installation of energy efficient equipment

PRIDE IN OUR PAST—FAITH IN OUR FUTURE



The Maine Association of proudly dedicates the 2024 Annual Business Directory to Frank Melberg for his dedication, commitment, knowledge, and friendship to our members and this industry.

Frank is the oldest of 3 siblings graduating from Silver Lake High Regional School in 1999, little did he know his Spanish teacher sophomore year, Richard Warnock would become his future father-in-law. After working his way through the University of Massachusetts at Amherst, he graduated with an economics/finance degree in 2003.

His career at Emerson Swan started in 2003 as he joined the inside sales distribution products team. During his tenure inside he learned from some industry legends in Ed Froment and Peter Knights. His appetite for learning was insatiable, staying late and arriving early. He honed his heating skills for more than 3 years then was given the opportunity to go to outside sales in 2006. His first territory was in Emerson Swan's Region 3 where he worked under the tutelage of Bob Oppel covering central Mass and Rhode Island. Within a few years his presentation and troubleshooting skills were that of an industry pro, his relationships with wholesalers and contractors allowed him to be a trusted advisor and a very successful salesman.

His journey north started in 2009 when he was given the opportunity to take over the great state of Maine with a future path to sales management. He moved up to Portsmouth NH and hit the ground running. It did not take Frank long to relate to the customer base in Maine and create quite a reputation as one of the best salespeople in the industry. During this time frame he did the best sales job of his life and convinced Kyla Warnock to move north to Portsmouth where they were later married. In 2012 Frank was promoted to regional manager for Maine, New Hampshire, and Vermont. Always willing to take on a challenge Frank managed multiple regions and became a vice president in 2019 and a senior vice president and member of the senior management team in 2023.

On the personal side Kyla and Frank live in North Hampton NH with their two lovely daughters Isabella (10) and Sofia (6), the pride and joy of Frank and Kyla's life. Frank enjoys going to the girl's sporting events, traveling with the family, skiing, golf, and finding great restaurants and specialty shops. A music enthusiast and guitarist that has passed his passion on to his daughters.

Colleagues at Emerson Swan could not be prouder of his accomplishments both professionally and personally.

Table of Contents

Code of Ethics.....	2
2024 Dedication.....	3
PHCC National Benefits.....	14-15
MAPHCC Member Application.....	136
Exhibit Spaces.....	8
Exhibitors.....	9
Plumbing Apprenticeship.....	14
Scholarship Information.....	129-130
Calendars: 2024-2025.....	134-135

Greetings From...

PHCC National President.....	16
PHCC of Maine President.....	17

Photo Spreads

22nd Annual Golf Tournament, Brunswick Golf Club.....	12-13
Annual Tradeshow, Augusta Civic Center.....	10-11
Maine PHCC Past Presidents.....	20

Directories, Boards & Associations

Buyers Guide.....	118-127
Local Plumbing Inspectors.....	102-116
Maine PHCC Associate Members.....	37-41
Maine PHCC Members.....	31-33
PHCC National Association.....	7
Plumbers Examining Board.....	47
Maine Fuel Board.....	48
New England PHCC Associations.....	15
Maine PHCC Officers & Directors.....	22
Maine PHCC Past Presidents.....	21
Subsurface Wastewater Unit.....	49

Advertisers

American Standard / Emerson Swan.....	119, 131
AOSmith/Urell.....	23, 126
Automag.....	Inside Back Cover
Bangor Pipe & Supply.....	35, 118
Bell/Simons.....	42 & 43, 118
Blue Monster.....	117
Efficiency Maine.....	54 & 55, 119
F.W. Webb Co.....	Inside Front Cover, 119
Federated Insurance.....	44, 120
Ferguson.....	Back Cover, 120
FIA.....	27, 121
Granite Group, The.....	34, 121
Heat Flo.....	18 & 19, 122
Hews Co., Inc.....	56 & 57, 122
Homans.....	122, 128
IAPMO.....	46, 122
J.H. Pokorny Associates.....	36, 122
John Stack Sales.....	24, 123
K. Ross Co.....	101, 123
Magic Carpet.....	30, 123
MEMA Technical Education Center.....	28 & 29, 123
Pape Chevrolet.....	52 & 53, 124
Portland Group, The.....	51, 124
R.W. Beckett.....	45, 125
RST Thermal.....	26, 125
State Water Heaters / Urell.....	126, 133
Summit Natural Gas.....	50, 125

Charts & Graphs References

Celcius to Farenheit Chart.....	98
Circumferences and Areas	78
Competitive Cross Reference: Hydronic Expansion Tank.....	95
Competitive Cross Reference: Thermal Expansion Tank.....	97
Conversion Factors.....	76 & 77
Cutting, Notching, boring Holes for a Framing Member.....	91-93
Determining Heat Load: Installing Radiation.....	81
Fuel Consumption and Energy Cost.....	86
Fuel Oil Tanks.....	76
Gas Input to Burner in Cubic Feet per Hour.....	68 & 69
Guidelines for Hydronic Radiant Floor Heating.....	88
Hot Water Storage Tanks and Generators.....	75
Information About LP-Gas.....	74
Inspection of Chimneys.....	66
LP Gas Code Table.....	90
Location of ASME Containers.....	89
Location of Condensation Drainage.....	71
Location of DOT Cylinders.....	75
Maine Home Construction Contracts.....	99 & 100
Max. Capacity of Pipe w/ Pressure Drop of .5 IWC.....	72
Nozzle Flow Rate vs Pressure	67
Pipes and Cylinders: Contents in U.S. Gallons.....	79
Radiator Ratings.....	82
Sizing: Hydronic Expansion Tank.....	94
Sizing: Pipes Propane.....	73
Sizing: Twin Pipes in Second, Single, or Integral.....	91
Sizing: Portable Water Thermal Expansion Tank.....	96
Symbols: Air Conditioning.....	62 & 63
Symbols: Fitting and Valve.....	61
Symbols: Heating.....	64
Symbols: Piping.....	65
Symbols: Plumbing.....	61
Symbols: Ventilating.....	64
Tube Type Radiators.....	83
Typical Degree Day for a Few Locations.....	87
Vent Pressures: Plastic Piping & Special Vent Gas.....	70
Wall Type Radiators.....	84
Water Content for Existing Radiation/Piping.....	85
Zoning Made Easy: Rules of Thumb.....	80

MAINE'S LARGEST INDUSTRY TRADE SHOW!

129TH Annual Maine PHCC EXPO

Show 12PM–4PM

March 22nd, 2024 • Augusta Civic Center

New Products, and Technology
Raffle Drawings Throughout the show
•Manufacturer Giveaways
Plenty of FREE PARKING•Apprenticeship Contest
Pre-Registration Includes – Tee Shirt, Lunch and all Seminars

MAINE FUEL CODE

8:30 – 10:00 AM OR 10:30 AM – 12:00 PM

Code update and review of current adopted codes that pertain to the oil, propane and natural gas industry. This presentation will consist of a power point presentation and an open floor for questions during the presentation. Solid fuel codes will be addressed on an as needed basis.

Presented by State Fuel inspectors.

MAINE STATE INTERNAL PLUMBING CODE

8:30 - 10:15 AM OR 10:30 AM – 12:15 PM

Common Plumbing Code Issues discussed and an open floor for questions. New all gender bathroom allowance in code and how fixture counts apply. Online licensing process. Manufactured housing being allowed to acquire plumbing permits. Brent Lawson, State Site Evaluator will be there if anyone has questions about subsurface plumbing code questions. Paul Demers, State Code Official, will also be present to answer questions about building code.

Presented by Michael Day, State Plumbing Inspector

THE IN'S AND OUT'S OF BALANCED VENTILATION

11:00 - 12:30 PM

This seminar will cover the most important topics relating to indoor air quality, energy recovery and balanced ventilation. We will answer questions such as, Why do we need fresh air? How do HRV's and ERV's work and why do we need them? Topics will include defrost options, control selections, sizing, selecting units, installation configurations, system balancing and maintenance.

Presented by Wayne Fisher,

Director of Business Development and Training Lifebreath: Indoor Air Systems

PLAN OF EXHIBIT SPACES

AUGUSTA CIVIC CENTER

EVERYONE IS WELCOME!

APPRENTICESHIP CONTEST

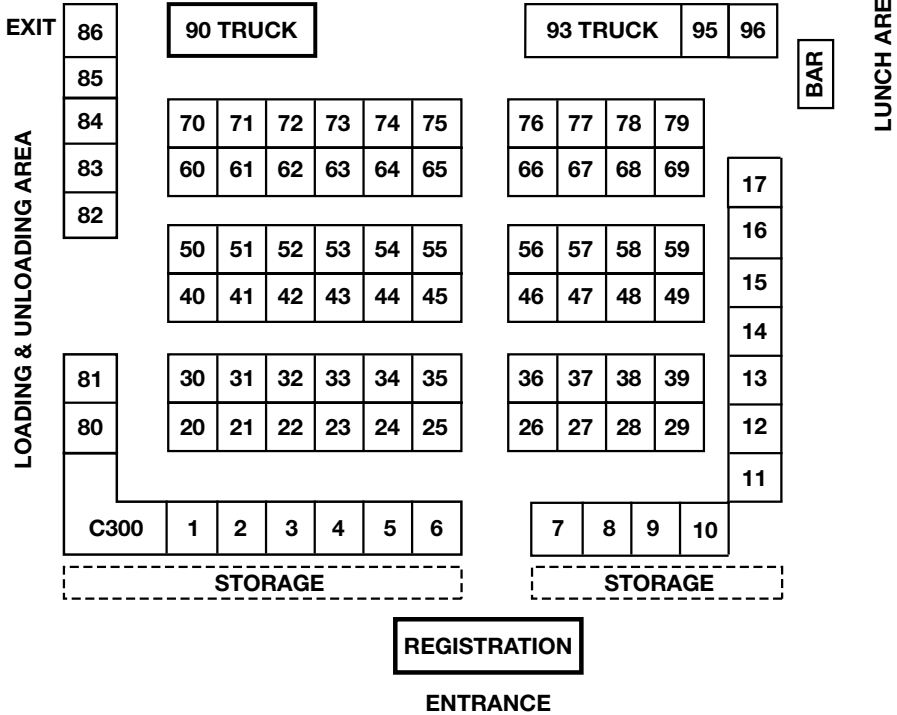

THANK YOU
TO OUR 2024 EXPO SPONSORS:



Great people. Great products.

Official Bag Sponsor



T-Shirt Sponsor



Grand Prize Raffle
 Sponsor



Seminar Refreshment
 Sponsors



EXHIBITORS 2024

(AS OF FEBRUARY 26, 2024)

1	Edos	44	Sweeney, Rogers & Geraghty
2	John Stack Sales Co., Inc	45	Sweeney, Rogers & Geraghty
3	John Stack Sales Co., Inc	46	Warwick Hangers
4	John Stack Sales Co., Inc	47	MRA
5	John Stack Sales Co., Inc	48	Federated Insurance
7	Cooper New England	49	Bell/Simons Co.
8	Cooper New England	50	Viega
9	Johnstone Supply	51	Maine Licensing Board
10	Johnstone Supply	52	Dyson Associates
11	The Walter F. Morris Company	53	Moen
12	The Walter F. Morris Company	54	Ferguson Enterprises
13	Emerson Swan, Inc.	55	Ferguson Enterprises
14	Emerson Swan, Inc.	56	Homans Associates
15	Emerson Swan, Inc.	57	Urell, Inc.
16	Winsupply of Portland	58	Urell, Inc.
17	Winsupply of Portland	59	Urell, Inc.
20	Futura Sales	60	QHT, Inc.
21	Edos	61	Metro Pipe & Supply
22	Maine PHCC	62	Mitsubishi Electric Trane HVAC
23	IAPMO	63	Bangor Pipe & Supply, Inc.
24	Summit Natural Gas	64	American National Insurance Co.
25	Davenport Associates	65	Milwaukee Tool
26	F. W. Webb Company	66	Rheem Water Heating
27	F. W. Webb Company	67	Rheem Water Heating
28	R W Beckett	68	Pilgrim Sales
29	The Granite Group	69	Urell, Inc.
30	Symmons	74	Messer Truck Equipment
31	Pendleton Associates/Thermo 2000	75	Efficiency Maine
32	Maine Natural Gas	76	Dan Davis Sales
33	FIA, Inc.	77	Dan Davis Sales
34	J. H. Pokorny Associates, LLC	78	Dan Davis Sales
35	Davenport Associates	79	Eastern Maine Dev. Corp
36	F. W. Webb Company	80	J & K Sales Associates
37	F. W. Webb Company	81	J & K Sales Associates
38	MEMA Technical Education Center	83	RST Thermal
39	The Granite Group	84	TSS Associates-Bosch
40	Viessman	85	Heat-flo
41	Rehau	86	David Gooding, Inc.
42	Runtal North America	C300, 301	Edos
43	Vortex Companies		





22ND ANNUAL GOLF TOURNAMENT

September 29, 2023
Brunswick Golf Club
Brunswick, Maine



Thank You to Our 2023 Golf Sponsors





APPRENTICESHIP CONTEST SPONSORS



Grand Prize Sponsor



Prize Sponsor



Prize Sponsor



Prize Sponsor

APPRENTICESHIP BOOTH SPONSORS



F.W. WEBB COMPANY



Great people. Great products.



PHCC NATIONAL ASSOCIATION

National Headquarters: PO Box 6808, Falls Church, VA 22046
1-800-533-7694 • Fax 703-237-7442 • www.phccweb.org

Joe Cornetta, President

547 Hempstead Tpke
Elmont, NY 11003-1852
(516) 476-0762
cornetta@naphcc.org

Rick Whitaker, President-Elect

PO Box 15668
Durham, NC 27704-0668
(919) 220-2554
rick@bbph.com

Jason Pritchard, Vice President

2825 S. 154th St
Seatac, WA 98188
(206) 2585270

Cynthia Sheridan, Chief Executive Officer

180 S. Washington St
Falls Church, VA 20046
(703) 237-8100/Fax (703) 237-7442
executiveoffice@naphcc.org

**Joe Whitney, Zone 1 Director,
New England Council President**

15 Hawk Hill Lane
Ipswich, MA 01938-3016
(978) 774-9800
jwhitney@gs-prop.com

NEW ENGLAND PHCC ASSOCIATIONS

Executive Director, Wayne Thomas

400 Washington St, Suite 401
Braintree, MA 02184
(781) 843-3800/Fax (781) 843-1178
wayne@phccma.org
www.phccma.org

Executive Director, Alice Ames

69 Rock Ridge Run
Cumberland, ME 04021
(207) 829-5055/Fax (207) 829-5031
aames2@maine.rr.com
www.maine-phcc.com

Executive Director, Corinne Riley

15 New England Way
Warwick, RI 02886
(401) 644-8435/Fax (401) 737-8869
riphcc@hotmail.com
www.riphcc.org

Executive Director, Gina Scumaci

PO Box 226
Fishers Island, NY 06390
(203) 379-3007/Fax (860) 828-2070
execdirector@ct-phcc.org
www.ct-phcc.org



GREETINGS FROM

Joe Cornetta

PHCC National Association President



We're passionate people at PHCC. We know we have a crucial duty to our communities and to our industry. Every day, our good work is protecting public health and safety. At the same time, we have to run our businesses efficiently, productively, and profitably. Fortunately, we have the people of PHCC to advocate on our behalf at all levels of government and to provide resources and best practices to help us do what we could never do alone.

PHCC of Maine is a testament to the power of those people. For more than a century, the passionate folks in the plumbing and HVAC industry in your state have been helping each other with business-building resources so that you can provide clean air and clean water to every corner, from your majestic mountains to your scenic shorelines.

As you gather for the 129th Maine PHCC EXPO in Augusta on March 22, be sure to *leverage all those opportunities* – top-tier education sessions, the latest products and technology, deep conversations with industry experts and peers, even inspiration from young apprentices – to better your business. At the same time, *appreciate the history*. This event is known at the “Best Show in New England” for a reason ... because it has a long-standing reputation for effectively fueling your profession today and ensuring its future is strong. You play a part in that!

Personally, my business is so much better because of PHCC. I'm able to hire better employees, manage my business better, evaluate jobs better, protect my customers better. And as your PHCC—National president, I see first-hand how National is continuing to strengthen its programs and resources to strengthen your business, including:

- Providing the latest information on today's business environment and trends through Business Intelligence resources from PHCC.
- Boosting peer-to-peer engagement, education, business coaching, and more through our Enhanced Service Groups.
- Providing a one-stop resource for education through the PHCC Academy®.
- Relaunching our Finance Bootcamp ... and kicking off a Contracts Bootcamp later this year.
- Staying on top of regulatory and legislative activity that impacts your business, especially changes in refrigerants and HVAC equipment as well as rebates from the Inflation Reduction Act for installing energy efficient equipment.

I am *particularly* passionate about PHCC's advocacy efforts, having witnessed the power of collaboration in fighting for consumer fuel choice in my state of New York. Quite literally, there is power in united voices, which is why *we need you* at the **2024 PHCC Legislative Conference, May 21-22, in Washington, D.C.**

Of course, PHCC's CONNECT conference and trade show is your best opportunity all year long to share knowledge with your professional peers across the country, overcome your business challenges, and help elevate the industry. You don't want to miss this year's **reimagined CONNECT, Oct. 7-10, in beautiful Birmingham, Alabama.** (By the way, Birmingham just may be America's best-kept secret ... I hope to see you there!)

It's my true honor to serve you as national president this year.

Proudly,

Joe Cornetta
President, PHCC-National Association



**PLUMBING-HEATING-COOLING
CONTRACTORS ASSOCIATION®**
Best People. Best Practices:™

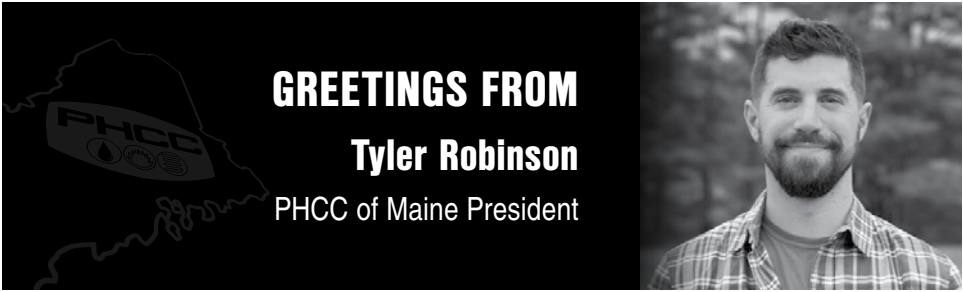

Greetings fellow industry members,

I would like to extend a huge thank you to all of our members and associates for continuing to show their support for the Maine PHCC. 2023 has proven to be yet another year of success for our industry in this great state. We would like to thank all of the men and women of our suppliers, distributors, and product support teams for continuing to provide us with every piece of material necessary to keep our customers safe and comfortable. The strong relationships we form and maintain are vital to the survival of our businesses.

As always, over the last year Maine PHCC has been working diligently to further our exposure to the consumer and build membership. Without the hard work of both our national partners and our local chapter, members of this industry would be left unprotected from unfair regulations, laws and code changes. Our advocacy for this industry is unparalleled, and is becoming increasingly needed as we advance.

If you are not a member, I strongly urge you to start a discussion with one of our members present at the show, or at any time, and see why you should join us. The PHCC is a group of professional contractors that represents your needs and speaks for you at legislative, licensing, and labor boards. As this industry's leading professionals, each one of you should want to assist in ensuring that nothing negatively affecting us is passed by our government, be it local or national. Membership and participation is a vital necessity to keep up with our ever advancing world. Regardless of your membership status, we hope to hear any and all concerns or needs and look forward to seeing continued growth of our chapters membership.

Respectfully,

Tyler Robinson
PHCC of Maine, President



Heat-flo



Heat-flo's *Industry-Topping* Features and Benefits

VISIT US AT
BOOTH #84

Brass T&P Valve Factory-Installed.

All fittings on top for neat & clean installation, including all stainless steel cold water dip tube.

Durable Thermoplastic Jacket will not dent or corrode.

Large anode rod to fight against harsh water environments.

Over 2" of R-15+ Insulation.

Large smooth-wall coil collects less lime and sediment.

Brass Drain Valve factory-installed.



Heat-flo's HF-40: 40-gallon Indirect Fired Water Heater

Features and benefits of Heat-flo's HF-40 are equal to or consistent with Heat-flo's Buffer/Storage/Multi-Energy Tanks and Electric Water Heaters.

Heat-flo, Inc.

P.O. Box 612
Uxbridge, MA 01569 USA
www.heat-flo.com

Phone: 508-278-2400

Fax: 508-278-2466

E-mail: Sales@heat-flo.com



PROUDLY DESIGNED
AND MANUFACTURED
IN THE USA.



Past Presidents of the Maine Association of Plumbing, Heating, Cooling Contractors
Front (left to right): Robert Miles, Sr., Richard Waltz, Sr., Elmer (Ted) Walker
Back (left to right): Kim Girard, Sal Raia, Roland (Beef) L'Heureux, David Walker



John Gerber



Anthony LaMarre



Ralph (Fred) Blake



Jim Godbout



Frank North



Jon Harmer



Mark Oliver



Charlie Burnham



Kevin Purnell



Front (left to right): Don Dube and Executive Director Alice Ames
Back (left to right): Ron Dunsmoor, Jim Robinson, Robert Miles, Jr.

PAST PRESIDENTS OF THE MAINE ASSOCIATION SINCE 1930

1930	*George Noyes, Presque Isle	1977	*W. Franklin Blake, Portland
1931	*George Noyes, Presque Isle	1978	*W. Franklin Blake, Portland
1932	*Neils Knudsen, Falmouth	1979	George Ray, Ellsworth
1933	*Neils Knudsen, Falmouth	1980	George Ray, Ellsworth
1934	*John Kerrigan, Lewiston	1981	Thomas Kelley, Portland
1935	*John Kerrigan, Lewiston	1982	Thomas Kelley, Portland
1936	*Ernest R. Graham, Bar Harbor	1983	Roland L'Heureux, Kennebunk
1937	*Ernest R. Graham, Bar Harbor	1984	Roland L'Heureux, Kennebunk
1938	*Wilbur F. Blake, Portland	1985	*Kim Girard, Old Orchard
1939	*Wilbur F. Blake, Portland	1986	*Kim Girard, Old Orchard
1940	*Charles B. Davis, Waterville	1987	Salvatore Raia, Portland
1941	*Charles B. Davis, Waterville	1988	Salvatore Raia, Portland
1942	*Jerry A. Cyr, Fort Fairfield	1989	David Walker, Poland Springs
1943	*Ralph L. Clarke, Rumford	1990	David Walker, Poland Springs
1944	*Ralph L. Clarke, Rumford	1991	Robert Miles, Sr., Yarmouth
1945	*Ernest N. Cunningham, Portland	1992	Ralph F. Blake, Jr., Portland
1946	*Hilman A. Williams, Westbrook	1993	Ralph F. Blake, Jr., Portland
1947	*William A. Sparks, Brunswick	1994	Donald Dube, Biddeford
1948	*Philip Reuben, Portland	1995	Donald Dube, Biddeford
1949	*Arthur I. Knight, Westbrook	1996	John H. Gerber, Portland
1950	*C. Merton Douglas, Brunswick	1997	John H. Gerber, Portland
1951	*Andrew P. Iverson, Portland	1998	James Robinson, Portland
1952	*William P. Clapman, Waterville	1999	James Robinson, Portland
1953	*Bernard T. Young, Auburn	2000	Robert Miles, Jr., Yarmouth
1954	*Emil N. Iverson, Portland	2001	Robert Miles, Jr., Yarmouth
1955	*Frederick B. Chick, Westbrook	2002	Ronald Dunsmoor, Biddeford
1956	*Stuart W. Littlefield, Kennebunk	2003	Ronald Dunsmoor, Biddeford
1957	*Silas Fowler, Lincoln	2004	Anthony Lamarre, Waterville
1958	*Harry B. Chase, Westbrook	2005	Anthony Lamarre, Waterville
1959	*Richard P. Waltz, Portland	2006	James Godbout, Biddeford
1960	*Arthur W. Ford, Auburn	2007	James Godbout, Biddeford
1961	*Ernest W. Maxcy, Camden	2008	Frank North, Naples
1962	*Ralph F. Blake, Portland	2009	Frank North, Naples
1963	*Franklin E. Hannaford, Farmington	2010	Frank North, Naples
1964	*Richard J. Carvel, Portland	2011	Ron Dunsmoor, Biddeford
1965	*William J. Steeves, Millinocket	2012	Jon Harmer, New Gloucester
1966	Harry E. Nason, Jr., Auburn	2013	Jon Harmer, New Gloucester
1967	*Marlowe J. LeBarge, Kennebunk	2014	Jon Harmer, New Gloucester
1968	*Filmore O. Frye, Lincoln	2015	Mark Oliver, Kennebunk
1969	*Omer O. Oullette, Lewiston	2016	Mark Oliver, Kennebunk
1970	*Omer O. Oullette, Lewiston	2017	Charlie Burnham, Freeport
1971	Elmer F. Walker, Jr., Poland Springs	2018	Charlie Burnham, Freeport
1972	Elmer F. Walker, Jr., Poland Springs	2019	Kevin Purnell, Oakland
1973	*Martin Caron, South Portland	2020	Kevin Purnell, Oakland
1974	*Martin Caron, South Portland	2021	Kevin Purnell, Oakland
1975	*Ralph E. Clarke, Rumford	2022	Tyler Robinson, Gorham
1976	*Ralph E. Clarke, Rumford	2023	Tyler Robinson, Gorham

MAINE ASSOCIATION OF PLUMBING-HEATING-COOLING CONTRACTORS OFFICERS AND DIRECTORS

TYLER ROBINSON

President

Mainely Plumbing & Heating
674 Main St
Gorham, ME 04038
Tel: (207) 615-3503
trob207@gmail.com

MIKE LEVENSELLER

Vice President

PO Box 370
Oakland, ME 04963
Tel: (207) 465-9220
mlevenseller&granite-corp.com

JORDAN HARMER

Secretary

Harmer & Sons Plumbing & Heating
55 Swamp Rd
New Gloucester, ME 04260
Tel: (207) 926-5515
jordan@harmerandsons.com

KEVIN PURNELL

Treasurer

Granite Corp
PO Box 370
Oakland, ME 04963
Tel: (207) 465-9220
kevin@granite-corp.com

DIRECTORS

Jeff Duplessis, The Granite GroupRochester, NH
Tony LaMarre, Houle's Plg & HtgWaterville
Robert Miles, III, Bob Miles & SonFreeport
Mark Oliver, Garrett Pillsbury Plg & HtgKennebunk
Scott Libby, Royal River Heat Pumps.....Freeport
Charlie Burnham, Dead RiverFreeport

TRUSTEES

Bob Miles, Jr., Bob Miles & SonFreeport
Jon Harmer, Harmer & Son Plg & Htg.....New Gloucester
Jim Robinson, Mainely Plg & Htg.....Gorham

GET PUMPED!

Savings Are In The Air With The New CHP-120 Commercial Integrated Heat Pump Water Heater

Heat pump technology is designed to use significantly less electricity than traditional electric water heaters by transferring heat from the surrounding ambient air into the tank. Your customers can save up to \$3,500* per year in energy costs, while providing you with an easy-to-sell, easy-to-install commercial water heater that will have everyone feeling pumped!

- Up to \$3,500* per year in energy cost savings
- Perfect for light commercial applications
- ENERGY STAR® qualified with a COP of 4.2

AO Smith.

Learn more at hotwater.com

URELL

Proudly Representing AO Smith
in New England





JOHN STACK SALES COMPANY, INC.

SERVING THE NORTHEASTERN UNITED STATES FOR OVER 60 YEARS.

Main Office:

575 Wyoming Ave, Suite A
Wyoming, PA 18644

☎ 1 (888) 466-4328

☎ 1 (866) 634-7737

✉ info@stacksales.com



www.alroproducts.com

-Malleable iron pipe fitting, brass fittings and nipples, couplings, cast stem fittings, pipe hangers and accessories



www.argobaseboard.com

-Lo Trim & Panel Trim baseboard-



www.automagzonevalves.com

-Universal Replacement hydronic 100% USA made, and baseboard zone valves-



www.beacon-morris.com

-Twin Flo, Twin Pak, BRUT Gas fired unit heaters & convectors-

Lukens Metals



www.canfieldmetals.com

-Solder, lead, and caulking products, Lukens Metals-



www.kochfilter.com

-Multi-purpose high grade air filtration systems and filters-



www.laars.com

-Residential and commercial: Indirect water heaters, condensing wall mount and floor mount boilers. Instantaneous wall hung heaters-



www.maidmist.com

-Hydronic and Jacobus steam air vents-



www.mestek.com

-Hydronic baseboard lines-



www.millrose.com

-Abrasive brushes, compounds, and tools, and Teflon tapes-



www.thermodynamicsboiler.com

-Oil boilers, electric boilers, residential steel boilers, pool heaters-



www.westernpottery.com

-Full line of Vitreous china: toilets, lavs, pedestals, ADA Easy Height-



www.zilmetusa.com

-Expansion tanks, heat exchangers, Commercial ASME tanks, Flat plate heat exchangers, magnetic dirt separators, ActivFlo water conditioner -



Scan here for our Virtual Catalog

www.stacksales.com

New England Territory

MAINE ASSOCIATION OF PHCC MAN /WOMAN OF THE YEAR

YEAR	MAN/WOMAN OF THE YEAR	DEDICATION
1956		Arthur L. Knight
1957		Edward Colby
1958		Iver Iverson
1960		Ernest Cunningham
1962		E. W. Campbell
1964		Hilman O. Williams
1965		Joseph P. Welch
1966		George F. Scribner
1967		Harry B. Chase
1968		Neils M. Knudsen
1969		William Gower
1970		Richard Waltz, Sr.
1971		Ralph L. Clarke
1972		Arthur Ford
1973	Dick Carvel	Stanley Baker
1974	Arthur Ford	Omer Ouellette
1975		John Thornton
1977	Ralph Blake, Sr.	Andrew P. Iverson
1978	Ted Walker	Roger Ouelette
1979	Marty Caron	Fred Chick
1980	Lester Gross	Samuel Burokoff
1981	Donald McCubrey	Franklin Hannaford
1982	Bill & Bob Miles	William Steeves
1983	Sonny Blake	Ralph Blake, Sr.
1984	George Ray	Willis Johnson
1985	William Steeves	Marty Caron
1986	Thomas Kelley	Warren Charles
1987	Roland L'Heureux	William Miles, Sr.
1988	Lloyd Rainey	Lester F. Gross
1989	Dennis Steinert	John G. Morin
1990	Philip Lamourreux	Roland & Shirley L'Heureux
1991	John Gerber	Richard J. Carvel
1992	Salvatore Raia	Ted Walker
1993	David Walker	Richard and Jeanette Sylvester
1994	William Harmon	Richard R. Blais
1995	James Robinson	Donald McCubrey
1996	Donald Dube	Armand N. Houle
1997	Alice Ames	John H. Gerber
1998	Donald Dube	Ernie & Eleanor Goodwin
1999	Robert Miles, Sr.	Harland Hasey
2000	Shirley L'Heureux	Warren G. Lang
2001		Alan R. Urell
2002	James Robinson	Janey Miles
2003		Eric Whitten
2004		Donald Dube
2005		Salvatore Raia
2006		Caroll Houle
2007	Ronald Dunsmoor	Sonny Blake
2008		Ronald Dunsmoor
2009		Phyllis Waltz
2010		Don Rutherford
2011		Kim Girard
2012		William E. Miles, Jr.
2013		Don Farnham
2014		Marlowe LeBarge
2015		James Robinson
2016		Andy Allen
2017		John Provencal
2018		John Pope
2019		Paul Blagdon
2020		Brian Breton
2021		Robert Hardina
2022		John Pokorny
2023		Nate Bassett



2022 Line Card

RST Thermal, INC
 52 Ferry Street
 Fall River, MA 02721
 (P) 781-320-9910/(F) 781-320-9906
www.RSTThermal.com

RST Thermal provides reliable technical resources and support to help our partners grow and succeed. Since 1989 we have been leaders in shaping how people heat, cool and ventilate their homes and businesses.

 HVAC Control Solutions	 Gas detection for HVAC
 Wall Mount HVAC	 Fans ALL sizes and ERVs
 Insulated under slab radiant grid system	 Energy Recovery Ventilators
 Process Chillers	 Electric Duct Heaters, Boilers, Make-Up Air, Steam Humidifiers
 Ductless mini-split cable	 Small duct, high velocity htg & A/C
 Heat Pumps	 Innovative zoning dampers & control boards for HVAC systems

Dylan Beauregard
 Inside Sales/Tech Support
 C// 508-212-4331 EXT 102
dylan@rstthermal.com

Kevin Bergeron
 Sales-CT/Western MA
 C// 860-256-8258 EXT 111
kevinb@rstthermal.com

Maryellen Hickey
 Support/Operations
 C// 508-254-5110 EXT 101
mehickey@rstthermal.com

Alex Toth
 Sales - ME/NH
 C// 207-805-4189 EXT 103
alex@rstthermal.com

Mark Toth
 Sales - ME/No MA/NH/VT
 C// 207-331-7919 EXT106
mark@rstthermal.com

Richard Trethewey
 Vice President
 C//617-320-1955 EXT 107
richard@rstthermal.com

Evan Trethewey
 President
 C// 617-320-1959 EXT 104
evan@rstthermal.com

CONSISTENCY BUILDS TRUST.



NOBLE[®]
FIRE TUBE



Meeting the boiler needs of every customer calls for industry-leading efficiency and installation flexibility.



KNIGHT[®]
FIRE TUBE BOILER

DESIGNED ★ ENGINEERED ★ ASSEMBLED
USA

 **Lochinvar**[®]
HIGH EFFICIENCY BOILERS & WATER HEATERS

 **FIA** INC.
FLUID INDUSTRIAL ASSOCIATES, INC.

Contact FIA for Sales, Support and Knowledge
www.fiainc.com

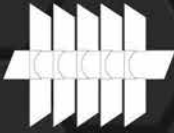

**MEMA TECHNICAL
EDUCATION CENTER**

**THE #1 HVAC
TRAINING
PROGRAM
IN THE
NORTHEAST**

- 🔥 HVAC-R
- 🔥 OILHEAT
- 🔥 NATURAL GAS
- 🔥 PROPANE
- 🔥 HEAT PUMPS
- 🔥 REFRIGERATION

**YOUR START
TO AN
ESSENTIAL
HVAC
CAREER!**



25 Greenwood Road, Brunswick, ME 04011
(207) 729-5298 | mtecenter.com

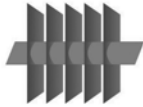

MEMA TECHNICAL EDUCATION CENTER

2024 COURSE SCHEDULE

HVAC PRO SEMESTER CLASS

Member: \$12,700; Non-Member: \$13,900
(includes tool bag valued over \$1,500)

Jan 8 - Mar 29

Apr 1 - Jun 28

Jul 8 - Sep 27

Sep 30 - Dec 20

OIL HEAT

OIL HEAT TECHNICIAN TRAINING:

Member: \$4,575; Non-Member: \$4,975

Jan 8 - Feb 9

Jul 8 - Aug 9

Feb 26 - Mar 29

Aug 26 - Sep 27

Apr 1 - May 3

Nov 18 - Dec 20

May 20 - Jun 21

Night Course/Saturdays: Sep 3 - Nov 21

EXAM PREP - MAINE STATE OILBURNER :

Member: \$199; Non-Member: \$299
(Journeyman & Master)

Mar 9, Jun 15, Oct 12

AC / HEAT PUMP

EPA 608 CERTIFICATION & REFRIGERANT RECOVERY:

Member: \$1,050; Non-Member: \$1,200

Feb 12 - Feb 16

Aug 12 - Aug 16

May 6 - May 10

Sep 30 - Oct 4

40 HOUR HEAT PUMP TRAINING:

Member: \$1,100; Non-Member: \$1,250

Feb 19 - Feb 23

Aug 19 - Aug 23

May 13 - May 17

Oct 7 - Oct 11

CFESA FOODSERVICE

CFESA FOODSERVICE EQUIPMENT TRAINING

Member: \$1,200; Non-Member: \$2,000

Feb 12 - Feb 16

Aug 19 - Aug 23

May 13 - May 17

Oct 7 - Oct 11

PROPANE/NATURAL GAS

APPLIANCE CONNECTION & SERVICE

Member: \$3,475; Non-Member: \$3,775

Jan 15 - Feb 9

Jul 15 - Aug 9

Mar 4 - Mar 29

Sep 3 - Sep 27

Apr 8 - May 3

Oct 21 - Nov 15

May 28 - Jun 21

Nov 25 - Dec 20

Night Course/Saturdays: Mar 12 - May 16

EXAM PREP - APPLIANCE CONNECTION & SERVICE, NFPA #54

Member: \$199; Non-Member: \$299

Mar 16, Jun 22, Oct 19

TANKSETTER & OUTSIDE PIPING:

Member: \$1,200; Non-Member: \$1,400

Jan 8 - Jan 16

Jul 8 - Jul 16

Feb 26 - Mar 5

Aug 26 - Sep 4

Apr 1 - Apr 9

Oct 15 - Oct 23

May 20 - May 29

Nov 18 - Nov 26

Night Course/Saturdays: Feb 20 - Mar 7

DELIVERY TECHNICIAN

Member: \$1,050; Non-Member: \$1,200

May 13 - May 16

Sep 30 - Oct 3

LARGE EQUIPMENT

Member: \$750; Non-Member: \$950

May 6 - May 8

Fall Date TBD

PLANT OPERATOR

Member: \$1,050; Non-Member: \$1,200

Aug 12 - Aug 15

OPERATOR QUALIFICATION

Summer Date TBD

25 Greenwood Road, Brunswick ME 04011 | 207-29-5298 | mtecenter.com



Water Damage or Frozen Pipes?

WE THAW!

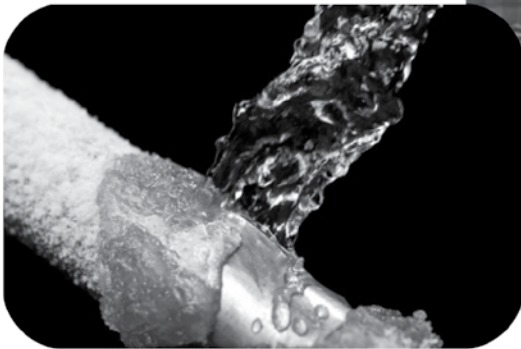
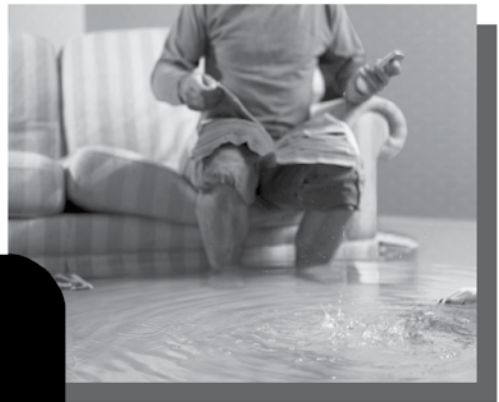

Magic Carpet Cleaning & Restoration

673 Main Street
South Portland, ME 04106

(207) 767-1359

Info@MagicCCR.com
www.MagicCCR.com

Directory of
MAINE PHCC MEMBERS

AARON FORD PLG & HTG

Aaron Ford
135 Wentzell Rd
Lichfield, ME 04350
Tel: (207) 462-1125
afordplumbing@outlook.com

ABM MECHANICAL, INC

Mike McHugh
33 Dowd Rd
Bangor, ME 04401-6733
Tel: (207) 992-9250
mmchugh@abmmechanical.com
www.abmmechanical.com

BOB MILES & SON PLG & HTG

Robert Miles, Jr. / Robert Miles, III
1162 US Route 1
Freeport, ME 04032
Tel: (207) 869-9140
Fax: (207) 869-6193
bob@bobmilesinc.com
Rob.miles@bobmilesinc.com
www.bobmilesinc.com

BROOKSIDE PLUMBING

Michael Eaton
10 Brookside Lane
Hope, ME 04847
Tel: (207) 785-2145
brooksid@tidewater.net
www.brooksideplumbing.co

DAVID AASKOV, INC

David Aaskov
87 Brown Cove Rd
Windham, ME 04062
Tel: (207) 893-0333

DOG HOUSE ENERGY

John Scola
PO Box 405
Freeport, ME 04032
Tel: (207) 865-0989
john@doghouseheating.com
www.doghouseheating.com

DON MORIN ASSOCIATION, INC

148 Randlett Dr
Laconia, NH 03246
Tel: 1-800-353-2366
Fax: 603-524-2673
dmorinassoc@metrocast.net
www.donmorin.com

DOUG BARKER PLG & HTG

Doug Barker
69 Gould Rd
Leeds, ME 04263-3052
Tel: (207) 931-9300
Fax: (207) 524-2153
douglas.barker27@yahoo.com

**ELEMENTS PLG, HTG,
& CLG, INC.**

Jason Lamb/Theodore Olson
5 Keystone Dr
Windham, ME 04062
Tel: (207) 239-7700
elementsphc@gmail.com

GARRETT PILLSBURY

Mark Oliver
119 York St
Kennebunk, ME 04043
Tel: (207) 985-2130
Fax: (207) 467-3497
moliver@garrett-pillsbury.com
www.garrett-pillsbury.com

**GAYNOR HEATING
& COOLING**

Daniel Gaynor
1098 East Conway Rd
Center Conway, NH 03813
Tel: (603) 818-3481
gaynorheatingandcooling@gmail.com
www.gaynorheatingandcooling.com

GENERAL MECHANIX

Steven Farren
PO Box 137 / 168 Center St
Bangor, ME 04402
Tel: (207) 951-0817
info@generalmechanix.com
www.generalmechanix.com

THE GERBER CO., INC

Neal Gerber
4 Gray Rd
Falmouth, ME 04105
Tel: (207) 797-0500
Fax: (207) 797-5757
gerberco@maine.rr.com

GRANITE CORP

Kevin Purnell / Mike Levenseller
PO Box 370
Oakland, ME 04963
Tel: (207) 465-9229
Fax: (207) 465-2684
kevin@granite-corp.com
mlevenseller@granite-corp.com
www.granite-corp.com

HARLEY PLG & HTG PLUS

Chad Peasley
142 Farm Rd
Bangor, ME 04401
Tel: (207) 990-2200
Fax: (207) 942-3295
info@harleytheplumber.com
www.harleytheplumber.com

HARMER & SONS PLG & HTG

Jon Harmer / Jordan Harmer
55 Swamp Rd
New Gloucester, ME 04260
Tel: (207) 926-5515
harmersons@aol.com
Jordan@harmerandsons.com
www.harmerandsonsplumbing.com

HOULE'S PLG & HTG

Anthony LaMarre
19 North St
Waterville, ME 04901
Tel: (207) 872-6762
Fax: (207) 877-5691
ajlamarre@hotmail.com
www.houlesphac.com

JIM GODBOUT PLG & HTG

James Godbout
PO Box 365 / 48 Elm St
Biddeford, ME 04005
Tel: (207) 283-1200
Fax: (207) 283-2739
jjim@jimgodbout.com
www.jimgodbout.com

JOHNSON & JORDAN

Jim Tarbox
18 Mussey Rd
Scarborough, ME 04074
Tel: (207) 883-8345
Fax: (207) 883-8619
jtarbox@johnsonandjordan.com
www.johnsonandjordan.net

KNOWLES MECHANICAL

Keith Knowles
1097 Route 3
South China, ME 04358
Tel: (207) 445-4092
Fax: (207) 445-2160
knowlesmech1@gmail.com
www.knowlesmechanal.com

MAINELY PLG & HTG, INC

Jim Robinson / Tyler Robinson
674 Main St
Gorham, ME 04038
Tel: (207) 854-4969
Fax: (207) 854-2232
jim@mainelyplumbing.com
trob207@gmail.com
www.mainelyplumbing.com

MID-COAST ENERGY SYSTEMS, INC

William Morgner
PO Box 1118
Damariscotta, ME 04543
Tel: (207) 563-5147
Fax: (207) 563-1138
bmorgner@midcoastenergysystems.com
www.midcoastenergysystems.com

NICHOLS PLUMBING AND DRAIN CLEANING

Field Glover
26C Airport Road
Brewer, ME 04412
Tel: (207) 989-1533
info@nichols-plumbing.com
www.nichols-plumbing.com

RANOR, INC

Norm St. Pierre
P.O Box 5036 / 962 Maine St
North Jay, ME 04262
Tel: (207) 645-5109
Fax: (207) 645-5108
ranor@ranormech.com
www.ranormech.com

RICHARD P. WALTZ PLG & HTG

Marlene Foudriat
179 Presumpscot St
Portland, ME 04103
Tel: (207) 772-2801
Fax: (207) 773-3114
info@richardpwaltz.com
www.richardpwaltz.com

RIVERSIDE MECHANICAL, INC

Donny Neuts
27 Rebecca Way
Falmouth, ME 04105
Tel: (207) 874-1992
Fax: (207) 874-2283
don@riversidemechanicalinc.com
www.riversidemechanicalinc.com

ROYAL RIVER HEAT PUMPS

Scott Libby
353 US Route 1
Freeport, ME 04032
Tel: (207) 400-4065
scott@royalriverheatpumps.com

SPECIALTY SERVICES CORP

Andy Witham
1766 Federal Rd
Livermore, ME 04253
Tel: (207) 897-3900
awitham@specialtyservicesme.com

**WALDO COUNTY
OIL & PROPANE**

Joseph Irish
PO Box 2
Troy, ME 04987
Tel: (207) 948-2600
Fax: (207) 948-2698
jirish@uninets.net
www.waldocountyoil.com

WARREN MECHANICAL

Nathan Metivier
39 Warren Ave
Westbrook, ME 04092
Tel: (207) 856-6746
nmetivier@warrenmech.com
www.warrenmech.com

WINDSOR CONSTRUCTION

King Weinstein
198 Saco Ave
Old Orchard Beach, ME 04064
Tel: (207) 934-7622
Fax: (207) 934-1566
king198@icloud.com



Great people. Great products.



SINK & SPOUT

Bath, Kitchen and Lighting by The Granite Group

Maine's Award-Winning Home for **EVERYTHING** in:
**Plumbing, Heating, Cooling, Piping, Water Systems,
Energy, Bath, Kitchen, and Lighting products**



The Granite Group is a PROUD
Sponsor of the **Maine PHCC**



thegranitegroup.com | sinkandspout.com



Bangor Pipe & Supply, Inc.

YOUR MAINE SUPPLIER

PROUDLY SERVING MAINE TRADESMEN SINCE 1984

BANGOR

PO Box 1569 • 69 Farm Rd • Bangor, Maine 04401

Tel: (207) 942-1200 • 1-800-439-PIPE (7473) • Fax: 1-833-404-2717

ELLSWORTH

55 Foster St • Ellsworth, Maine 04605

Tel: (207) 667-5346 • 1-800-540-5346 • Fax: 1-833-404-2718

STOCKING DISTRIBUTORS OF:

American Standard

Smith Cast Iron Boilers

Granby Furnaces

Biasi Radiant Panels

Pex Plmg & Htg Systems

Oasis Bath Modules

Myers Pumps

Amtrol Boilermate

Biasi Boilers

Riobel Faucets

Heat Flo Indirect Water Heaters

State Water Heaters

Suntemp Baseboard

Liberty Sewage Systems

Radiant Heat Design and Layout

IBC Boilers

Penzotti Panel Radiators

IBC Indirect Tanks

Dayton SS Sinks

Sloan

Taco Hydronics

Apollo Press Fittings

Grundfos Pumps

Symmons Faucets

COMMERCIAL & RESIDENTIAL



BIG DIPPER

www.thermaco.com/big-dipper

FLUSHMATE

www.flushmate.com

EVAC LIFE SCIENCES DIV.

www.evac.com

GEORG FISCHER

www.sloane.gfpiping.com

GUARDIAN EQUIPMENT COMPANY

www.gesafety.com

KALDEWEI

www.kaldewei.us

KEMPER WATER CONTROL SYSTEMS

www.kemperwatercontrol.com

KARP ASSOC., INC.

www.karpinc.com

LEONARD VALVE COMPANY

www.leonardvalve.com

MCGUIRE MANUFACTURING CO., INC.

www.mcguiremfg.com

METCRAFT INDUSTRIES INC.

www.metcraftindustries.com

OASIS

www.oasiscoolers.com

SLOAN

www.sloan.com

TRAPZILLA

www.thermaco.com/trapzilla

UV PURE

www.uvpure.com

WATERSAVER

www.wsflab.com

JHP email: ask@jhpokorny.net

Directory of
MAINE PHCC ASSOCIATE MEMBERS

**AMERICAN NATIONAL
INSURANCE**

John Heller

434 Main St #2
Damariscotta, ME 04572
Tel: (207) 563-5200
jheller@american-national.com

BANGOR PIPE & SUPPLY

69 Farm Rd
Bangor, ME 04401
Tel: (207) 942-1200
Fax: (207) 942-8762
www.bangorpipe.com

BELL-SIMONS COMPANY

Rick Breton

56 Airport Rd
Waterville, ME 04901
Tel: (207) 284-5975
Fax: (207) 284-9038
www.bellsimons.com

**CENTRAL MAINE COMMUNITY
COLLEGE**

Marc Gilbert

1250 Turner St
Auburn, ME 04210
Tel: (207) 755-5440
mgilbert@cmcc.edu

COASTAL WINAIR

Ron Veilleux

27 Morin St
Biddeford, ME 04005
Tel: (207) 284-2406
Fax: (207) 284-2409
rjveilleux@winair.com
www.coastalwinair.com

**COOPER NEW ENGLAND
SALES**

649 Amity Rd, Suite 105
Bethany, CT 06524
Tel: (203) 720-7161
info@c-nes.com
www.c-nes.com

DAN DAVIS SALES, INC

Mike Levesque

PO Box 567
Springvale, ME 04083
Tel: (800) 410-8700
Fax: (207) 324-2217
info@dandavissales.com
www.dandavissales.com

DAVENPORT ASSOCIATES

Dan Davenport

75 Parker St
Wallingford, CT 06492
Tel: (203) 265-2389
Fax: (203) 269-5941
info@davenportassociates.com
www.davenportassociates.com

DYSON ASSOCIATES

Jennie Perefetuo

194 Kenwood Dr
New Britain, CT 06052
Tel: (860) 992-5663
jennie@dysonassoc.com

EDOS MANUFACTURERS' REP

Robert and Joannie OS

PO Box 378, 8-B West State St
Granby, MA 01033
Tel: (413) 467-9161
Fax: (413) 467-7824
www.edosonline.com
Sales Rep: Darren Webber
Cell: (207) 409-5787
Fax: (207) 929-3617
darren@edosonline.com

EMERSON SWAN

Frank Melberg, Tom Protasewich

300 Pond St
Randolph, MA 02368
Tel: (781) 986-2000
Toll Free: (800) 346-9215
Fax: (781) 986-2028
fmelberg@emersonswan.com
tprotasewich@emersonswan.com
www.emersonswan.com

ENERGY KINETICS

Jim Pike

51 Molasses Hill Rd
Lebanon, NJ 08833
Tel: (908) 735-2066
Fax: (908) 735-2068
jpik@energykinetics.com
www.energykinetics.com

F.W. WEBB

Greg Thompson

150 Postal Service Way
South Portland, ME 04106
Tel: (207) 772-8364
Fax: (207) 773-4571
glt@fwwebb.com
www.fwwebb.com

FEDERATED INSURANCE

Jon Medo

121 E. Park St
Owatonna, MN 55060
Tel: (800) 533-0472
jwmedo@fedins.com

Sales Rep: Phil Saraceno

89 Mussey Rd, Suite 201
Scarborough, ME 04070
Tel: (207) 272-6785
Fax: (888) 651-9155
pasaraceno@fedins.com

FERGUSON ENTERPRISES

Tim Fox

PO Box 3554
Portland, ME 04104
Tel: (207) 773-4755
Fax: (207) 772-2957
tim.fox@ferguson.com
www.ferguson.com

F I A, INC

Mark Cunniff

7 Sixth Rd
Woburn, MA 01801
Tel: (781) 938-8900
Toll Free: (800) 423-7187
Cell: 339-227-0472
Fax: (781) 933-3965
mcunniff@fiainc.com
www.fiainc.com

THE GRANITE GROUP

Jeff Duplessis

331 Warren Ave
Portland, ME 04103
Tel: (603) 234-4164
jduplessis@thegrانيتgroup.com
www.thegrانيتgroup.com
www.theultimatebathstore.com

HEAT-FLO

Rich Concoran

15 Megan Ct.
Uxbridge, MA 01569
rconcoran@heat-flo.com
Tel: (508) 278-2400
www.heat-flo.com

HEATING SOLUTIONS SALES

Lancaster, PA
Tel: (717) 239-7642
www.heatingsolutions.com

HOMANS ASSOCIATES

Caton Tompkins

111C Pinetree Industrial Pkwy
Portland, ME 04103
Tel: (800) 922-9554
ctompkins@homans.com
www.homans.com

IAPMO

Peter Kelly

141 North St
Weymouth, MA 02191
Tel: (909) 224-2198
peter.kelly@iapmo.org
www.iapmo.org

INTERNATIONAL CODE COUNCIL (ICC)

Gary Gauthier

41 Gumpus Rd
Lovell, MA 01854
Tel: (978) 735-5994
ggauthier@iccsafe.org

J.H. POKORNY ASSOCIATES

Jeff Hodgin

1502 Providence Hwy
Norwood, MA 02062
Tel: (781) 762-2661
Fax: (781) 762-5949
jeffh@jhpokorny.net
www.jhpokorny.net

J & K SALES ASSOCIATES

Chris Dewitt

101A E. Industrial Park Dr
Manchester, NH 03109
Tel: (603) 626-1901
Toll Free: (800) 654-0415
Fax: (603) 625-2842
chris@jandsales.com

JOHN STACK SALES COMPANY

Gary J. Stack

575 Wyoming Ave, Suite A
Wyoming, PA 18644
Tel: (570) 693-3050
Fax: (570) 693-2294
gjs@stacksales.com
www.stacksales.com

JOHNSTONE SUPPLY - BALSAN GROUP

Shawn Buck

195 Thatcher St
Bangor, ME 04401
Tel: (207) 942-0293
shawn.buck@johnstonesupply.com

K. ROSS CO

Matthew Ross

PO Box 162
Kingston, MA 02364
Tel: (508) 747-4493
Fax: (508) 746-6678
www.krossco.com

KENNEBEC VALLEY COMMUNITY COLLEGE

Robert McLellan

92 Western Ave
Fairfield, ME 04937
Tel: (207) 453-5817
rmclellan@kvcc.me.edu

MAGIC CARPET & UPHOLSTERY CLEANING

Susan Dell'Aquila

623 Main St
South Portland, ME 04106
Tel: (207) 767-1359
Fax: (207) 347-7009
info@MagicCCR.com
www.MagicCCR.com

MAINE NATURAL GAS

Paul Wild

PO Box 99 / 4 Industrial Pkwy
Brunswick, ME 04011
Tel: (207) 729-0420 ext 105
Fax: (207) 729-9452
pwild@mainenaturalgas.com
www.mainenaturalgas.com

METROPOLITAN PIPE AND SUPPLY

Bill Sloan

100 West Road
Portsmouth, NH 03801
Tel: (207) 436-1400
Cell: (508) 414-4354
bsloan@metpipe.com

MILWAUKEE TOOL

Michael Marcasciano

13135 W. Lisbon Rd
Brookfield, WI 53005
Tel: (774) 218-8578
michael.marcasciano@milwaukeeetool.com

MOEN FAUCET

Billie Senzek

25300 Al Moen Dr
N. Olmstead, OH 44070
Tel: (603) 490-2612
billie.senzek@moen.com
www.moen.com

PAPE CHEVROLET

Ben Welch, III

425 Westbrook St
South Portland, ME 04106
Tel: (207) 775-6111
Fax: (207) 775-5309
benwelch@papechevrolet.com
www.papeauto.com

THE PORTLAND GROUP

Jeff Golojuch

91 Industrial Park Rd
Saco, ME 04072
Tel: (207) 283-8787
Fax: (207) 283-4848
jwg@theportlandgroup.com
www.theportlandgroup.com

QHT, INC

3560 Lafayette Rd
Portsmouth, NH 03801
Tel: (603) 334-6400
Fax: (877) 334-6401
info@qhtinc.com
www.qhtinc.com

R.W. BECKETT

Mary Hall

38251 Center Ridge Rd
North Ridgeville, OH 44039
Cell: (617) 894-0236
mhall@beckettcorp.com
www.beckettcorp.com

RINNAI AMERICAN CORPORATION

Michael Dupuis

103 International Dr
Peachtree City, GA 30267
Tel: (207) 806-9207
mdupuis@rinnai.us
www.rinnai.us

RST THERMAL

Mary Ellen Hickey

372 University Ave
Westwood, MA 02090
Tel: (781) 320-9910 or 02026
Fax: (781) 320-9906 or 3206
mehickey@rstthermal.com
www.rstreps.com

ROWE FORD

Tim Caron

91 Maine St
Westbrook, ME 04092
Tel: (207) 856-7993
Fax: (207) 854-1428
tcaron@roweford.com

RUNTAL NORTH AMERICA

Jon Wiberg

187 Neck Rd
Wardhill, MA 01835
Tel: (800) 526-2621
Cell: (603) 770-2078
Fax: (978) 372-7140
jonathan.wiberg@runtalnorthamerica.com
www.runtalnorthamerica.com

S. G. TORRICE

Tim Burton

80 Industrial Way
Wilmington, MA 01887
Tel: (207) 232-4986
tburton@sgtorrice.com
www.sgtorrice.com

SOUTHERN MAINE COMMUNITY COLLEGE (SMCC)

Don Bailey & Craig Carney

Fort Rd
South Portland, ME 04106
Tel: (207) 400-7833
dbailey@smccme.edu
Craig Carney
Tel: (207) 741-5619
ccarney@smccme.edu

SUMMIT NATURAL GAS

Jessica Carter

442 Civic Center Dr, Suite 100
Augusta, ME 04330
Tel: (800) 909-7642
Fax: (207) 624-8009
jcarter@summitnaturalgas.com
www.summitnaturalgas.com

SWEENEY ROGERS GERAGHTY, INC

Kevin Geraghty

250 Richmond St
Raynham, MA 02767
Tel: (508) 822-3939
Fax: (508) 822-0553
www.srgirep.com

SYMMONS INDUSTRIES, INC

54 Profile Ave
Concord, NH 03301
Tel: (781) 848-2250
Fax: (781) 843-3849
www.symmons.com
Sales Rep: Dale Emerson
Cell: (603) 491-6666
demerson@symmons.com

TSS ASSOCIATES, INC

Steven Grady
433 New Karner Road
Albany, NY 12205
Tel: (518) 621-7283
steve@tssassociatesinc.com
www.tssassociatesinc.com

U.S. BOILER CO.

Chris Massey
PO Box 3079
Lancaster, PA 17604-3079
Tel: (717) 397-4701
cmassey@usboiler.net
www.usboiler.net
www.burnham.com

UNITED INSURANCE GROUP

Erik Casparius
470 Forest Ave
Portland, ME 04101
Tel: (207) 797-9400
Cell: (207) 619-9012
Fax: (207) 523-8057
erikcasparius@unitedinsurance.com
www.unitedinsurance.com

UNITIL

Kelly Fowler
376 Riverside Industrial Pkwy
Portland, ME 04103
Tel: (866) 933-3821
fowler@unitil.com

URELL, INC

Robert Thompson
PO Box 321
Watertown, MA 02471-0321
Tel: (207) 283-0474 & 617-923-9500
Fax: (617) 926-9414
bthompson@urell.com
www.urell.com

VIEGA

Tom Keefe
17 Elaine Dr
Nashua, NH 03062
Tel: (603) 494-5723
tom.keefe@viega.us
www.viega.net

**VISSMANN
MFG CO (US), INC**

Jim Bolduc
45 Access Rd
Warwick, RI 02886
Tel: (207) 532-8500
Fax: (401) 732-0590
bolj@viessmann.com
www.viessmann-us.com

WALTER F. MORRIS CO

Kyle Tasse
77 Green St
Foxboro, MA 02035
Tel: (800) 888-1922
Fax: (800) 888-1942
ktasse@morrismERCHANTS.com

WINSUPPLY OF PORTLAND

Nate Bassett
177 Cash St
South Portland, ME 04106
Tel: (207) 773-WINN (9466)
Fax: (207) 773-1533
nbassett@winsupplyinc.com
www.winsupplyofportland.com

WOLVERINE BRASS

Tim Ashe
2951 Hwy 501 East
Conway, SC 29526
Cell: (603) 953-5903
Toll Free: 1 (800) 944-9292
tim.ashe@ppg-inc.com
april.neely@ppg-inc.com
wanda.capps@ppg-inc.com
www.ppg-inc.com

THE BELL/SIMONS COMPANIES

Bell – Auburn: (207) 786-0129
 Bell – Bangor: (800) 438-4756
 Bell – Hancock: (800) 852-1282
 Bell – Sanford: (207) 490-2244

Bell – Biddeford: (207) 284-5975
 Simons – Portland: (800) 438-4757
 Bell – Waterville: (800) 437-8466

Saint Roch Cast Iron Boilers UNIVERSAL

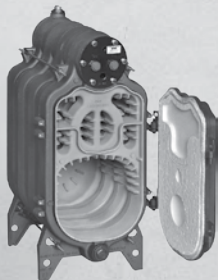

Use with or without coil.

STANDARD FEATURES

- 87% Energy Star Rated
- Limited Lifetime Warranty
- Hydrostat 3250TC W/ Low-Limit Disable
- 1 1/4" NPT Supply & Return Tappings
- 3/4" DHW NPT Tappings
- Full Swing Front Door- For Easy Service
- 6" Rear Flue
- Direct Vent 3 & 4 Section Boiler
- Available Burners:
 - Beckett (Oil)
 - Riello and Carlin (Gas & Oil)

Input Rates
 from 140,000 to 245,000 MBH



FINALLY A 3-PASS

TANKLESS BOILER!!!



LIGHT COMMERCIAL

3-PASS CAST IRON BOILER

Saint Roch Cast Iron Boilers OPTI MAJOR

STANDARD FEATURES

- 87% Efficiency
- Limited 20 Year Warranty
- Hydrostat 3250Plus Control
- 2" NPT Return Tappings
- 2" NPT Supply Manifold w/ 4 3/4" Tappings
- Full Swing Front Door- For Easy Service
- 8" Rear Flue
- Installed Removable Cast-Iron Baffles
- Available Burners:
 - RIELLO** Energy For Life
 - Riello (Gas & Oil)

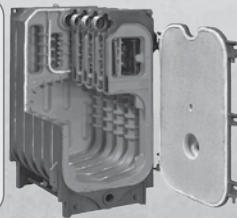

Input Rates
 from 267,000 to 667,000 MBH

www.qhtinc.com



THE BELL/SIMONS COMPANIES

Bell – Auburn: (207) 786-0129

Bell – Bangor: (800) 438-4756

Bell – Hancock: (800) 852-1282

Bell – Sanford: (207) 490-2244

Bell – Biddeford: (207) 284-5975

Simons – Portland: (800) 438-4757

Bell – Waterville: (800) 437-8466

PURMO 
RADIATORS AND FAN CONVECTORS



Purmo Bench Radiator
Unique functional design
Stylish symmetry and detailing
Color and size to suit every situation



Architectural Design Radiator
Available horizontal & vertical
Side panel & top grille included
Stylish thin replacement for baseboard

PurmoUSA.com
800-501-7697

Discover Indoor
Climate Comfort

QHT
INCORPORATED
The New Style of Warmth

YOUR BUSINESS CAN GROW WHEN YOU'RE IN THE KNOW

JOIN PHCC TODAY!



FEDERATED INSURANCE

It's Our Business to Protect Yours

Help Your Employees Make it Home Safe Today

Federated DriveSAFESM Telematics helps your employees improve their daily driving habits and return home safe at the end of the day.



AN ASSOCIATION MEMBER BENEFIT FOR 119 YEARS
DIRECT LOCAL MARKETING REPRESENTATIVES AUTO
PROPERTY AND CASUALTY SELF-INSURED RETENTION
POLICYHOLDER SURPLUS LIVE VOICE CUSTOMER SERVICE
MYSHELDSM TAILORED, INDUSTRY-SPECIFIC COVERAGE
BUSINESS SUCCESSION AND ESTATE PLANNING FINALE
FACE-TO-FACE RELATIONSHIPS FINANCIAL STRENGTH
MUTUAL COMPANY DIRECT CLAIM REPRESENTATIVES
SOASM EXCLUSIVE ASSOCIATION RECOMMENDATIONS
ESTATE PLANNING ATTORNEY NETWORK ANNUITIES

**IT'S OUR BUSINESS TO PROTECT
MAINE PHCC MEMBERS**

WE'RE BETTER TOGETHER LIFE AND DISABILITY INCOME
PRIVATE BONUS PLANS KEY PERSON COVERAGE
WORKERS COMPENSATION HIRING PRACTICES
FEDERATED DRIVESAFESM TELEMATICS SOLUTION
RISK MANAGEMENT RESOURCE CENTER
EMPLOYMENT REQUIRED PRACTICES INSURANCE
EMPLOYMENT LAW ATTORNEY NETWORK
BONDING EMPLOYEE SAFETY TRAINING
RISK MANAGEMENT ACADEMY
WORKERS COMPENSATION CENTER
FIELD RISK CONSULTANTS
SURVEILLANCE CENTER
SURETY SPECIALISTS

Scan to learn more
about DriveSAFE
TELEMATICS.



The content of this publication is for general information purposes only. Consult with a qualified professional when you have detailed questions regarding any topic in this publication.

Commercial Insurance | Property & Casualty | Life & Disability Income | Workers Compensation | Business Succession and Estate Planning | Bonding
Federated Mutual Insurance Company and its subsidiaries** | federatedinsurance.com

22-01 06 12 21 *100 A.M. Best Rating Guide Information at www.aetna.com. **Not licensed in all states. © 2022 Federated Mutual Insurance Company

Carbon Reduction From Tank-To-Flame™ Unmatched.



LEARN MORE AT
BECKETTCORP.COM

Beckett®

UNIFORM CODES

COMPREHENSIVE AND SUSTAINABLE



LIVE BY THE CODE
LIVE IT – LEARN IT – BUILD IT



ORDER NOW

WWW.IAPMOSTORE.ORG | 1-800-85-IAPMO

@IAPMO2021



DEPARTMENT OF PROFESSIONAL AND FINANCIAL REGULATION
OFFICE OF LICENSING AND REGISTRATION

PLUMBERS' EXAMINING BOARD

5 Member Board

(Currently 3 members serving)

BOARD MEMBER NAME	SEAT QUALIFICATION DESCRIPTION
Percy L. Brown, Jr.	Master Plumber Master Plumber who is a member of a bona fide labor organization
Nicholas Adams	Master Plumber who has been engaged in plumbing inspections for at least 4 years and is employed by a municipality
Robert B. Hodgkin	Master Plumber
VACANT	Public Member

www.maine.gov/professionallicensing

PLUMBERS' EXAMINING BOARD BOARD STAFF

BOARD INSPECTORS GENERAL EMAIL ADDRESS: plumbers.code@maine.gov

BOARD LICENSING STAFF EMAIL ADDRESS: plumbers.board@maine.gov

BOARD INSPECTORS GENERAL VOICEMAIL NUMBER: 207-624-8627

Michael Day, Senior Plumbing Inspector (michael.w.day@maine.gov)

(207) 624-8639

Cell: (207) 592-6362

Karen Ross, Licensing Supervisor, Interim Board Manager (karen.ross@maine.gov)

(207) 624-8414

Matthew Fournier (matthew.fournier@maine.gov)

(207) 624-8479

Tyler Robiinson (tyler.robinson@maine.gov)

(207) 624-8586



DEPARTMENT OF PROFESSIONAL AND FINANCIAL REGULATION
OFFICE OF LICENSING AND REGISTRATION

MAINE FUEL BOARD

9 Member Board

(Currently 5 members serving)

BOARD MEMBER NAME	SEAT QUALIFICATION DESCRIPTION
Mark Bossie , Board Chairperson	Propane and Natural Gas Technician and works in the natural gas industry
David Foster	Master Oil Burner Technician with the solid fuel authority
Loren Gordon	Master Oil Burner Technician
Maynard W. Waltz, Jr.	Propane and Natural Gas Technician
Mark Anderson	Propane and Natural Gas Technician
Paul F. McClay	Public Member
Richard McCarthy	Appointed by the Commissioner of Public Safety as the Commissioner's representative
Beau Libby	Master Oil Burner Technician and Propane and Natural Gas Technician
VACANT	Master Oil Burner Technician with the master solid fuel authority

MAINE FUEL BOARD

BOARD STAFF

BOARD INSPECTORS GENERAL EMAIL ADDRESS: fuel.code@maine.gov

BOARD LICENSING STAFF GENERAL EMAIL ADDRESS: fuel.board@maine.gov

BOARD INSPECTORS GENERAL VOICEMAIL NUMBER: 207-624-8627

Dale D. Hersey, Fuel Inspector (dale.d.hersey@maine.gov)	(207) 592-5864
Cecil B. Hafford, Fuel Inspector (cecil.b.hafford@maine.gov)	(207) 592-5043
Bruce Bristow, Inspector (bruce.bristow@maine.gov)	(207) 592-4516
Paul Moody, Fuel Inspector (paul.w.moody@maine.gov)	(207) 446-2826
Karen Ross, Licensing Supervisor , Interim Board Manager (karen.ross@maine.gov)	(207) 624-8414
Matthew Fournier (matthew.fournier@maine.gov)	(207) 624-8479
Tyler Robiinson (tyler.robinson@maine.gov)	(207) 624-8586

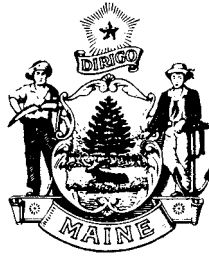

DIVISION OF ENVIRONMENTAL HEALTH SUBSURFACE WASTEWATER TEAM AND MAINE CDC DRINKING WATER PROGRAM

**286 WATER ST, 3RD FLOOR, AUGUSTA, ME 04333
GENERAL PHONE: (207) 287-2070 FAX: (207) 287-4172**

Subsurface Wastewater Team Contacts

Team Leader

Alex Pugh, Senior Geologist
Tel: (207) 592-2086
Email: alex.l.pugh@maine.gov

State Site Evaluator

Brent Lawson, State Plumbing Inspector
Tel: (207) 592-7376
Email: brent.lawson@maine.gov

Engineered Systems

Vacant

Private Well Coordinator

Haig Brochu
Tel: (207) 592-3190
Email: haig.brochu@maine.gov

Maine CDC Drinking Water

Drinking Water Program Director

Amy Lachance
Tel: (207) 557-2380
Email: amy.lachance@maine.gov



*It's Only
Natural*™

HVAC Contractors play an important role in making Maine homes and businesses more energy efficient – and comfortable – with natural gas.

Natural gas can be used for:

Heating

Water heating

Fireplaces

Cooking

Back-up generators

And more!

If you're interested in learning more about natural gas, we'd love to connect with you! Give us a call at **207-621-8000 ext. 6** or visit our website at SummitNaturalGasMaine.com

Thank You

to our HVAC Contractors!



THE PORTLAND GROUP

Creating Comfort Since 1930.

The Portland Group is a full service plumbing, heating and air conditioning supplier.

Come visit our Saco Branch

Conveniently located off the Maine Turnpike.

Plumbing Fixtures & Fittings

Kohler Sterling Gerber Duravit Ultra Bath
Aker Grohe Delta And many more...

Boilers

HTP IBC Pensotti
Viessmann Munchkin

Furnaces & Air Conditioning

Concord – *A competitive line of products without a compromise in quality!*

ZoomlockMAX – *refrigerant tool and fittings*

Specialty Tools Viega Pro Press Mega Press

And many more great heating and cooling products, like **Uponor** radiant heating products, **First Company** hydro-air, **DeHoust** double-wall oil tanks, **Modine** unit heaters, **Space Pak** high velocity air conditioning, **Fujitsu** ductless...



91 Industrial Park Road
Saco, ME 04072-1804
Toll Free: 1-866-796-8787

PAPE CHEVROLET

Ask about

- 1) The GM Goodwrench
Fleet Card*
- 2) Chevrolet Commercial
Customer Choice*
- 3) Fleet incentives*

1-800-485-2500 • 775-6111
benwelch@papechevrolet.com

Cell: 207-776-4030

425 Westbrook St., South Portland

Shop Online at www.papechevrolet.com

Hours: Monday-Thursday 8–8; Friday 8–6; Saturday 8–5



PAPE CHEVROLET



*Proud to be a
Convention
sponsor!*

1-800-485-2500 • 775-6111
benwelch@papechevrolet.com

Cell: 207-776-4030

425 Westbrook St., South Portland

Shop Online at www.papechevrolet.com

Hours: Monday-Thursday 8-8; Friday 8-6; Saturday 8-5



Heat pump water heaters cost less with Efficiency Maine discounts.

They also have long warranties
and high capacities.

That's why tens of thousands of Mainers own them.

Ask your distributor.

efficiencymaine.com
866-376-2463



Get free leads from Efficiency Maine

Become a registered vendor to be listed on our website's installer locator. Each year it attracts over 40,000 Mainers searching for an installer.



Scan the QR code
to get listed at no cost.

Relevant licenses, proof of insurance, and other requirements apply.

efficiencymaine.com
866-376-2463





CLASSIC SERVICE VAN

INCREASED FUEL EFFICIENCY & ORGANIZATION



50% + **10%** = **INCREASED PAYLOAD**

Lighter Than Steel/FRP Bodies

Average Fuel Savings

Best Service Body Industry ROI

CONTACT US TODAY TO LEARN MORE ABOUT OUR COMPLETE PRODUCT LINE



QUALITY EQUIPMENT, PARTS & SERVICE SINCE 1927

190 Rumery Street, South Portland, ME 04106

4 Ryan Road, Bow, NH 03304

www.hewscos.com | info@hewscos.com | 1.800.234.4397



STORAGE SOLUTIONS

UNMATCHED SECURITY & DURABILITY

Your tools and equipment belong on the shelf, not on the floor ...

Make Hews Company your go-to supplier for WEATHER GUARD® specialty storage packages and accessories customized to your needs and specifications:

- Adjustable Shelving
- Toolboxes
- Truck & Ladder Racks
- Storage Accessories
- Customized Bulkheads
- & more!

CONTACT US TODAY TO LEARN HOW WE CAN CUSTOMIZE YOUR VEHICLE

HEWS
TRUCK BODIES & EQUIPMENT

QUALITY EQUIPMENT, PARTS & SERVICE SINCE 1927

190 Rumery Street, South Portland, ME 04106

4 Ryan Road, Bow, NH 03304

www.hewsc.com | info@hewsc.com | 1.800.234.4397

PHCC—National Member Benefits

Here's what you need to know.

PHCC—National membership offers a variety of programs, education and services to keep your business in the know.
Engagement opportunities are here for you — just plug in!



ADVOCACY

- Federal legislative and regulatory representation
- State and local legislative and regulatory assistance
- State legislative and regulatory online tracking tool
- Representation on code bodies and industry coalitions
- Reinforcement of industry standards that protect public health and safety
- Annual legislative conference
- Alerts on laws, regulations and code changes
- Grassroots network
- PAC activities



WORKFORCE & PROFESSIONAL DEVELOPMENT TRAINING

- Free monthly webinars for members
- PHCCCONNECT annual conference and tradeshow offering tailored P-H-C education
- Face-to-face learning opportunities
- Career and job fair materials



BROUGHT TO YOU BY THE PHCC EDUCATIONAL FOUNDATION

- Plumbing and HVACR apprentice training
- Plumbing and HVACR Workforce Readiness course
- Plumbing Pre-Apprentice course
- Fast Track to Service Plumbing course
- Foremen workshop
- Assessment tests
- Essentials of Project Management class
- Plumbing and HVAC apprentice contest
- Scholarships



BEST PRACTICES, COMMUNICATION & NETWORKING

- Safety and risk management tools
- Access to subject matter experts
- PHCC water supply calculator app
- Monthly electronic newsletters
- Award winning magazine *Solutions*
- PHCC contractor online directory
- PHCC Online Buyer's Guide
- Online member communities



SAVINGS & DISCOUNTS

- PHCC industry partnerships with manufacturers and product providers to the P-H-C trade
- PHCC Labor Unit Database subscription
- Members-only discounts on programs, events and services



BUSINESS INTELLIGENCE

- Regular PHCC members-only business intelligence reports and insights, forward-facing statistics
- Monthly *Insta-Intel* report
- Quarterly *Competitive Edge* report



CONSUMER AWARENESS

- Find A Contractor online directory
- Branded PHCC outreach



PLUMBING-HEATING-COOLING CONTRACTORS' ASSOCIATION®
Best People. Best Practices.



ENHANCED SERVICE GROUPS (ESG)

- Quality Service Contractors (QSC)
 - » QSC Flat Rate Pricing Software
 - » One Power Meeting Registration Per Year
 - » A Complimentary, Comprehensive One-Hour Virtual Business Evaluation with a QSC Business Coach - variety of offerings available
 - » QSC's Online Community
 - » QSC's Rebate Program
 - » Library of Helpful Tools
 - » Specialized Peer Groups
- Construction Contractors' Alliance (CCA)
 - » Provides contractors with a means to find solutions to the many issues new construction contractors face. CCA serves PHCC's plumbing and mechanical contractors specializing in residential, industrial, commercial and institutional new construction.
- Union-Affiliated Contractors (UAC)
 - » Seminars offering targeting topics that are useful to union operated contractors. Topics like collective bargaining, benefits and Anti-Trust may be offered. Check out <https://community.phccweb.org/uac/home> for upcoming seminars.
- PHCC—National Auxiliary
 - » Women and men with the purpose of working in partnership with the plumbing, heating and cooling industry through scholarships, education, and industry support. They are comprised of individuals who have a wide variety of backgrounds. The common denominator, however, is an interest in the P-H-C industry.

PHCC membership pays for itself. *Just plug in!*

Member Savings and Discounts

- **Aramark:** 25% discount on uniforms.
- **Code Books:** Discounts vary by chapter.
- **ConsensusDocs:** 20% discount on subscriptions to standard construction contracts.
- **Exxon/Mobil:** 5 cent savings per gallon of gas using Fleet National card.
- **Home Depot Pro and HD Supply:** Two "Preferred Partner" programs with substantial savings for PHCC members: Home Depot Pro for retail and Home Depot Supply for wholesale.
- **Labor Unit Database:** 30-day free trial and \$100 discount off subscription renewal.
- **Market Hardware:** Free consultation and discount on web sites and marketing services.
- **Monthly Webinars:** \$360 value (\$35/ea. for non-members).
- **PHCCCONNECT Conference and Tradeshow:** \$100 discount off each member registration.
- **Solutions** magazine subscription: \$30 value
- **Time Communications:** Discounted monthly rate on call management systems.
- **Pink Callers:** Access to an administrative support solution that assigns customer service reps to support home service business remotely.
- **Plumbing and HVACR Apprentice eLearning Programs:** Discounts vary by chapter.
- **Plumbing and HVACR Textbooks:** Up to 25% discount through your chapter.
- **US Bank:** Eligible for a 15-minute consultation to discuss how your business expenses can become opportunities to increase cash flow, lengthen operating cycle, and earn more rewards.
- **Who's Who Directory:** Contact information for your fellow PHCC members across the nation. Free to PHCC members; \$75 non-member

Resources for Members



Plumbing and HVACR Workforce Readiness: Online course provides individuals with an introduction to working in the plumbing-heating-cooling industry.



TechLine: Expert advice on code questions and clarifications.



Safety Program Builder: Available from Federated Insurance, allows contractors to customize efforts that illustrate your commitment to ensuring safety in your workplace.



Overhead and Profit Calculator: This simple software tool helps business owners calculate their real costs and find the right selling price for their company.



PHCC Water Supply Calculator App: Offers a single resource to determine water supply fixture units and minimum fixture branch sizes for common plumbing fixtures, typical pressure drops in water meters, equivalent lengths of fittings, and more.



Multi-Employer 401(k) Retirement Program: PHCC members can choose among several 401(k) retirement program options offered by Lincoln Financial Group through Certified Financial Services.



Publications: Members receive *Solutions* magazine, *PHCC Online* and the *PHCC Advocate* newsletter, chock full of valuable news and information to help run your business and stay current on industry legislation and regulations.

JOIN PHCC TODAY!

CONTACT US: 207-829-5055 www.maine-phcc.com | phccweb.org | phccfoundation.org



@phccnatl



@PHCCNational



naphcc



NationalPHCC



Plumbing-Heating-Cooling Contractors-National Association

Additional benefits and savings available through PHCC's state and local chapters.

SOME USEFUL CHARTS AND GRAPHS



PLUMBING SYMBOLS

This standard has been developed by the ASA Sectional Committee on Standardization of Graphical Symbols and Abbreviations for Use on Drawings, Y32. The work of this committee is under the joint sponsorship of the American Institute of Electrical Engineers and the American Society of Mechanical Engineers.

This standard, one of a group which will ultimately replace the present American Standard Graphical Symbols for Use on Drawings and Mechanical Engineering, Z32.2.2-1949, replaces pages 4 through 9 of Z32.2-1949.

In preparing this list of Plumbing Symbols for Use on Drawings, Architects and Engineers were contacted in Boston, Chicago, New York, Philadelphia and Pittsburgh, as well as the resources of the two largest manufacturers of plumbing goods.

Based on the information made available to the committee, the symbols shown are a minimum requirement.

Following approval of the sectional committee and sponsor organizations, the proposal was presented to the American Standards Association for approval and designation as an American Standard. This was granted on October 11, 1955.

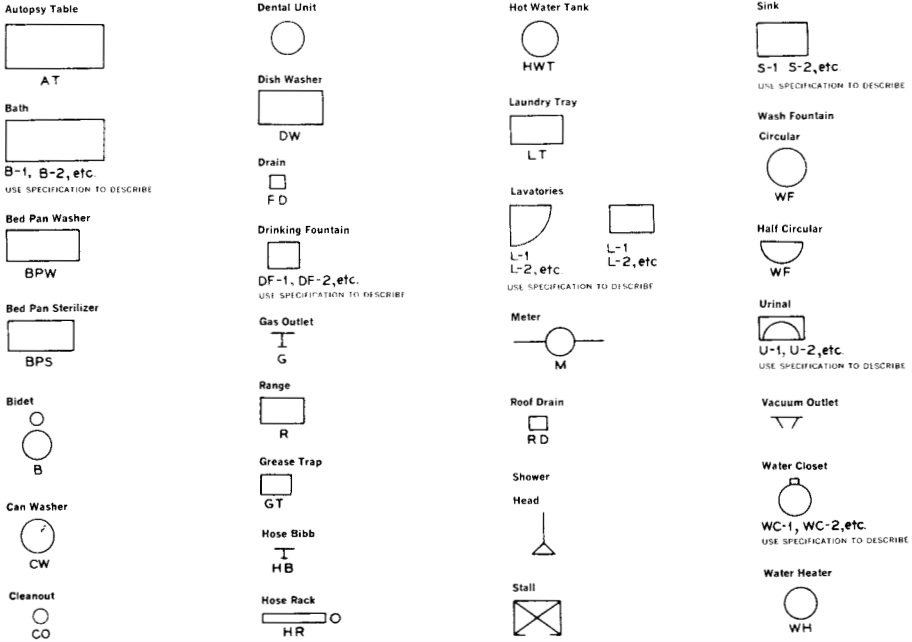

FITTING & VALVE SYMBOLS

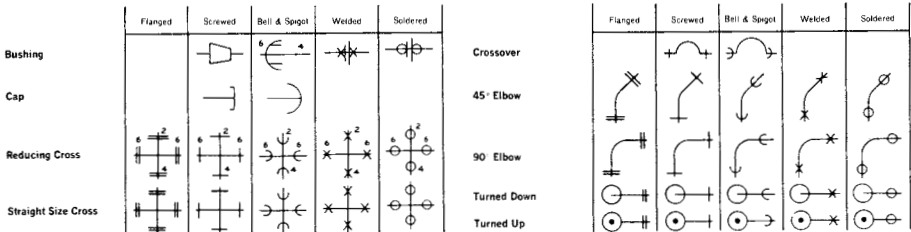

AIR CONDITIONING SYMBOLS

Immersion Cooling Unit



Low Side Float



Motor-Compressor, Enclosed Crankcase, Reciprocating, Direct Connected



Motor-Compressor, Enclosed Crankcase, Rotary, Direct Connected

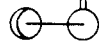

Motor-Compressor, Sealed Crankcase, Reciprocating

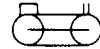

Motor-Compressor, Sealed Crankcase, Rotary

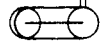

Pressurestat

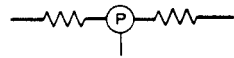

Pressure Switch

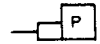

Pressure Switch with High Pressure Cut-Out



Receiver, Horizontal

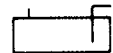

Receiver, Vertical



Scale Trap



Spray Pond

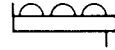

Thermal Bulb

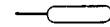

Thermostat (Remote Bulb)



Valve, Automatic Expansion



Valve, Compressor Suction Pressure Limiting, Throttling Type (Compressor Side)

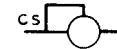

Valve, Constant Pressure, Suction

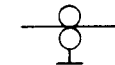

Valve, Evaporator Pressure Regulating, Snap Action

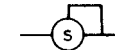

Valve, Evaporator Pressure Regulating, Thermostatic Throttling Type



Valve, Evaporator Pressure Regulating, Throttling Type (Evaporator Side)

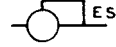

Valve, Hand Expansion



Valve, Magnetic Stop



Valve, Snap Action



Valve, Suction Vapor Regulating

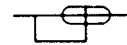

Valve, Thermo Suction

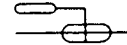

Valve, Thermostatic Expansion



Valve, Water

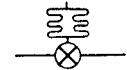

Vibration Absorber, Line



AIR CONDITIONING SYMBOLS

Capillary Tube



Compressor



Compressor, Enclosed, Crankcase, Rotary, Belted



Compressor, Open Crankcase, Reciprocating, Belted



Compressor, Open Crankcase, Reciprocating, Direct Drive



Condenser, Air Cooled, Finned, Forced Air

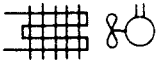

Condenser, Air Cooled, Finned, Static



Condenser, Water Cooled, Concentric Tube in a Tube

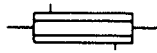

Condenser, Water Cooled, Shell and Coil

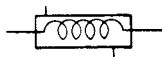

Condenser, Water Cooled, Shell and Tube

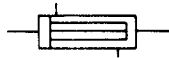

Condensing Unit, Air Cooled

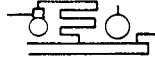

Condensing Unit, Water Cooled

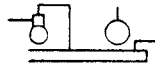

Cooling tower



Dryer



Evaporative Condenser



Evaporator, Circular, Ceiling Type, Finned



Evaporator, Manifolder, Bare Tube, Gravity Air

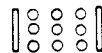

Evaporator, Manifolder, Finned, Forced Air

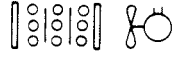

Evaporator, Manifolder, Finned, Gravity Air

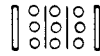

Evaporator, Plate Coils, Headered or Manifold



Filter, Line

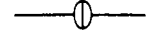

Filter & Strainer, Line



Finned Type Cooling Unit, Natural Convection

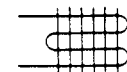

Forced Convection Cooling Unit

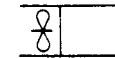

Gauge



High Side Float



HEATING SYMBOLS



Lock and Shield Valve

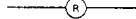

Relief Valve (either pressure or vacuum)



Reducing Pressure Valve



Vent Point

VENTILATING SYMBOLS

Access Door

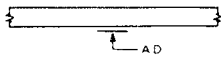

Duct (1st Figure, Side Shown;
2nd Side Not Shown)

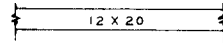

Inclined Rise in Respect
to Air Flow

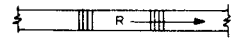

Adjustable Blank Off

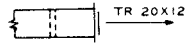

Duct Section
(Exhaust or Return)

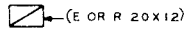

Intake Louvers on Screen

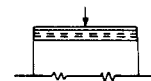

Adjustable Plaque

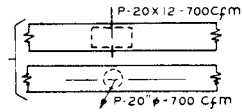

Duct Section (Supply)

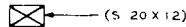

Louver Opening

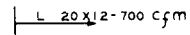

Automatic Dampers

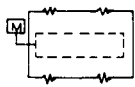

Exhaust Inlet Ceiling
(Indicate Type)

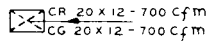

Supply Outlet Ceiling
(Indicate Type)



Canvas Connections

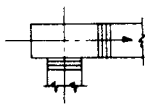

Exhaust Inlet Wall
(Indicate Type)

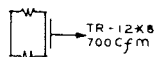

Supply Outlet Wall
(Indicate Type)

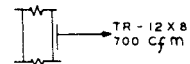

Deflecting Damper

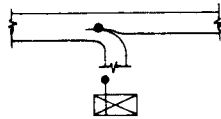

Fan and Motor with
Belt Guard

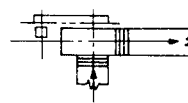

Vanes

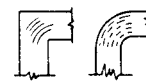

Direction of Flow

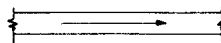

Inclined Drop in Respect
to Air Flow

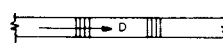

Volume Damper

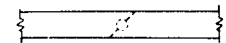

PIPING SYMBOLS

	AIR CONDITIONING		Low-Pressure Return
	Brine Return		Low-Pressure Steam
	Brine Supply		Make-Up Water
	Circulating Chilled or Hot-Water Flow		Medium Pressure Return
	Circulating Chilled or Hot-Water Return		Medium Pressure Steam
	Condenser Water Flow		PLUMBING
	Condenser Water Return		Acid Waste
	Drain		Cold Water
	Humidification Line		Compressed Air
	Make-Up Water		Drinking-Water Flow
	Refrigerant Discharge		Drinking-Water Return
	Refrigerant Liquid		Fire Line
	Refrigerant Suction		Gas
	HEATING		Hot Water
	Air-Relief Line		Hot-Water Return
	Boiler Blow Off		Soil, Waste or Leader (Above Grade)
	Compressed Air		Soil, Waste or Leader (Below Grade)
	Condensate or Vacuum Pump Discharge		Vacuum Cleaning
	Feedwater Pump Discharge		Vent
	Fuel-Oil Flow		PNEUMATIC TUBES
	Fuel-Oil Return		Tube Runs
	Fuel-Oil Tank Vent		SPRINKLERS
	High-Pressure Return		Branch and Head
	High-Pressure Steam		Drain
	Hot-Water Heating Return		Main Supplies
	Hot-Water Heating Supply		

HEATING SYMBOLS

	Air Eliminator		Thermostat
	Anchor		Boiler Return Trap
	Hanger or Support		Blast Thermostatic Trap
	Heat Exchanger		Float Trap
	Heat Transfer Surface, Plan (Indicate type such as: convector)		Float & Thermostatic Trap
	Pump (Indicate type such as: vacuum)		Thermostatic Trap
	Strainer		Unit Heater (Centrifugal Fan), Plan
	Tank (designate type)		Unit Heater (Propeller), Plan
	Thermometer		Unit Ventilator, Plan

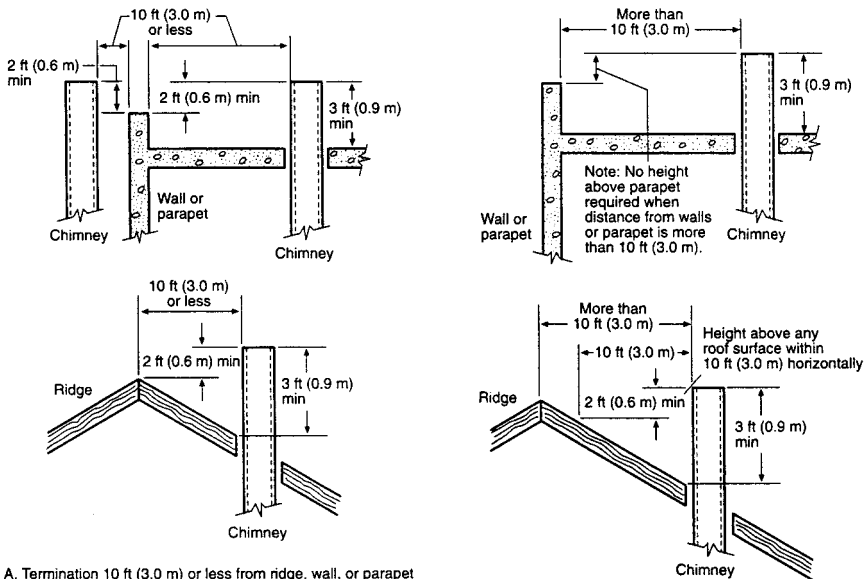

A. Termination 10 ft (3.0 m) or less from ridge, wall, or parapet

B. Termination more than 10 ft (3.0 m) from ridge, wall, or parapet

Figure 12. Typical Termination Locations for Chimneys and Single-Wall Metal Pipes Serving Residential-Type and Low-Heat Equipment.

7.5.4 Inspection of Chimneys.

(a) Before replacing an existing appliance or connecting a vent connector to a chimney, the chimney passageway shall be examined to ascertain that it is properly lined, clear and free of obstructions and shall be cleaned if previously used for venting solid or liquid fuel-burning appliances or fireplaces.

Exception: Where permitted by the authority having jurisdiction, existing chimneys shall be permitted to have their use continued when an appliance is replaced by an appliance of similar type, input rating, and efficiency.

(b) Cleanouts shall be examined to determine they will remain tightly closed when not in use.

(c) When inspection reveals that an existing chimney is not safe for the intended application, it shall be repaired, rebuilt, lined, relined, or replaced with a vent or chimney to conform to *Standard for Chimneys, Fireplaces, Vents, and Solid Fuel-Burning Appliances*, NFPA 211, or local building codes, and shall be suitable for the equipment to be attached.

Nozzle Flow Rate vs. Pressure (Approx.)

Flow Rating USGPH @ 100 PSI	Flow Rates in US GPH					
	Pressure PSI					
GPH	125	145	175	200	250	300
0.40	0.45	0.48	0.53	0.57	0.63	0.69
0.50	0.56	0.60	0.66	0.71	0.79	0.87
0.60	0.67	0.72	0.79	0.85	0.95	1.04
0.65	0.73	0.78	0.88	0.92	1.03	1.13
0.75	0.84	0.90	0.99	1.06	1.19	1.30
0.85	0.95	1.02	1.12	1.20	1.34	1.47
1.00	1.12	1.20	1.32	1.41	1.58	1.73
1.10	1.23	1.32	1.48	1.56	1.74	1.91
1.20	1.34	1.44	1.59	1.70	1.90	2.08
1.25	1.40	1.51	1.65	1.77	1.98	2.17
1.35	1.51	1.63	1.79	1.91	2.13	2.34
1.50	1.68	1.81	1.98	2.12	2.37	2.60
1.65	1.84	1.99	2.18	2.33	2.81	2.86
1.75	1.96	2.11	2.32	2.47	2.77	3.03
2.00	2.24	2.41	2.65	2.83	3.16	3.46
2.25	2.52	2.71	2.98	3.18	3.56	3.90
2.50	2.80	3.01	3.31	3.54	3.95	4.33
2.75	3.07	3.31	3.84	3.89	4.35	4.76
3.00	3.35	3.61	3.97	4.24	4.74	5.20
3.25	3.63	3.91	4.30	4.60	5.14	5.63
3.50	3.91	4.21	4.63	4.95	5.53	6.06
3.75	4.19	4.52	4.96	5.30	5.93	6.50
4.00	4.47	4.82	5.29	5.66	6.32	6.93
4.50	5.03	5.42	5.95	6.36	7.12	7.79
5.00	5.60	6.00	6.60	7.10	7.91	8.66
5.50	6.10	6.60	7.30	7.80	8.70	9.53
6.00	6.70	7.20	7.90	8.50	9.49	10.39
6.50	7.30	7.80	8.60	9.20	10.28	11.26
7.00	7.80	8.40	9.30	9.90	11.07	12.12
7.50	8.40	9.00	9.90	10.80	11.86	12.99
8.00	8.90	9.60	10.60	11.30	12.65	13.88
8.50	9.50	10.20	11.20	12.00	13.44	14.72
9.00	10.10	10.80	11.90	12.70	14.23	15.59
10.00	11.20	12.00	13.20	14.10	15.81	17.32
11.00	12.30	13.20	14.80	15.60	17.39	19.05
12.00	13.40	14.40	15.90	17.00	18.97	20.78
13.00	14.50	15.70	17.20	18.40	20.55	22.52
14.00	15.70	16.90	18.50	19.80	22.14	24.25

Table XIII Gas Input to Burner in Cubic Feet per Hour

Seconds for One Revolution	One-Half Cu Ft	Size of Test Meter Dial		Five Cu Ft
		One Cu Ft	Two Cu Ft	
Cubic Ft per Hour				
10	180	360	720	1,800
11	164	327	655	1,636
12	150	300	600	1,500
13	138	277	555	1,385
14	129	257	514	1,286
15	120	240	480	1,200
16	112	225	450	1,125
17	106	212	424	1,059
18	100	200	400	1,000
19	95	189	379	947
20	90	180	360	900
21	86	171	343	857
22	82	164	327	818
23	78	157	313	783
24	75	150	300	750
25	72	144	288	720
26	69	138	277	692
27	67	133	267	667
28	64	129	257	643
29	62	124	248	621
30	60	120	240	600
31	58	116	232	581
32	56	113	225	563
33	55	109	218	545
34	53	106	212	529
35	51	103	206	514
36	50	100	200	500
37	49	97	195	486
38	47	95	189	474
39	46	92	185	462
40	45	90	180	450
41	44	88	176	440
42	43	86	172	430
43	42	84	167	420
44	41	82	164	410
45	40	80	160	400
46	39	78	157	391
47	38	77	153	383
48	37	75	150	375
49	37	73	147	367

NOTE: To convert to Btu per hour, multiply by the Btu heating value of the gas used.

Table XIII continued

Seconds for One Revolution	One-Half Cu Ft	Size of Test Meter Dial		Five Cu Ft
		One Cu Ft	Two Cu Ft	
Cubic Ft per Hour				
50	36	72	144	360
51	35	71	141	353
52	35	69	138	346
53	34	68	136	340
54	33	67	133	333
55	33	65	131	327
56	32	64	129	321
57	32	63	126	316
58	31	62	124	310
59	30	61	122	305
60	30	60	120	300
62	29	58	116	290
64	29	56	112	281
66	29	54	109	273
68	28	53	106	265
70	26	51	103	257
72	25	50	100	250
74	24	48	97	243
76	24	47	95	237
78	23	46	92	231
80	22	45	90	225
82	22	44	88	220
84	21	43	86	214
86	21	42	84	209
88	20	41	82	205
90	20	40	80	200
94	19	38	76	192
98	18	37	74	184
100	18	36	72	180
104	17	35	69	173
108	17	33	67	167
112	16	32	64	161
116	15	31	62	155
120	15	30	60	150
130	14	28	55	138
140	13	26	51	129
150	12	24	48	120
160	11	22	45	112
170	11	21	42	106
180	10	20	40	100

NOTE: To convert to Btu per hour, multiply by the Btu heating value of the gas used.

Appliance Category†	Vent Pressure	Temperature Above/Below Defined in Relevant ANSI Standard	Comment
I	Non-Positive*	Above	Natural draft venting
II	Non-Positive*	Below	Materials must be corrosion resistant. Condensate must be drained.
III	Positive**	Above	Vent must be gastight.
IV	Positive**	Below	Vent must be liquid and gastight. Condensate must be drained.

*Non-positive vent pressure means that even if fans or blowers are used in the appliance or vent systems, venting is accomplished by natural draft. (The vent pressure is lower than the atmospheric pressure.)

**Positive vent pressure means that fans, blowers, or other means are used to propel vent gases through the vent at above atmospheric pressure.

†The newer models of appliances will be identified as Category I, II, III, or IV on the nameplate on the appliance and will be stated as such in the manufacturers' installation instructions.

7.4.2 Plastic Piping. Approved plastic piping shall be permitted to be used for venting equipment listed for use with such venting materials.

Prior to the introduction of high efficiency gas utilization equipment, plastic was prohibited as a vent material. High efficiency appliances reduced vent temperatures resulting in condensate formation, and as accumulation of condensate became a problem, plastic became the preferred material. Note that plastic vent materials can be used for listed gas utilization equipment only when specified in the manufacturers' instructions.

7.4.3 Special Gas Vent. Special gas vent shall be listed and installed in accordance with the terms of the special gas vent listing and the manufacturers' instructions.

Special gas vents are listed in accordance with UL 1738, *Standard for Safe Venting Systems for Gas-Burning Appliances*. Special gas vents will include in their installation instructions limitations on operating temperature, categories of appliance to be used with, clearance to combustible materials, and requirements for a vent cap, if any. All special gas vents are listed.

Condensation Drain

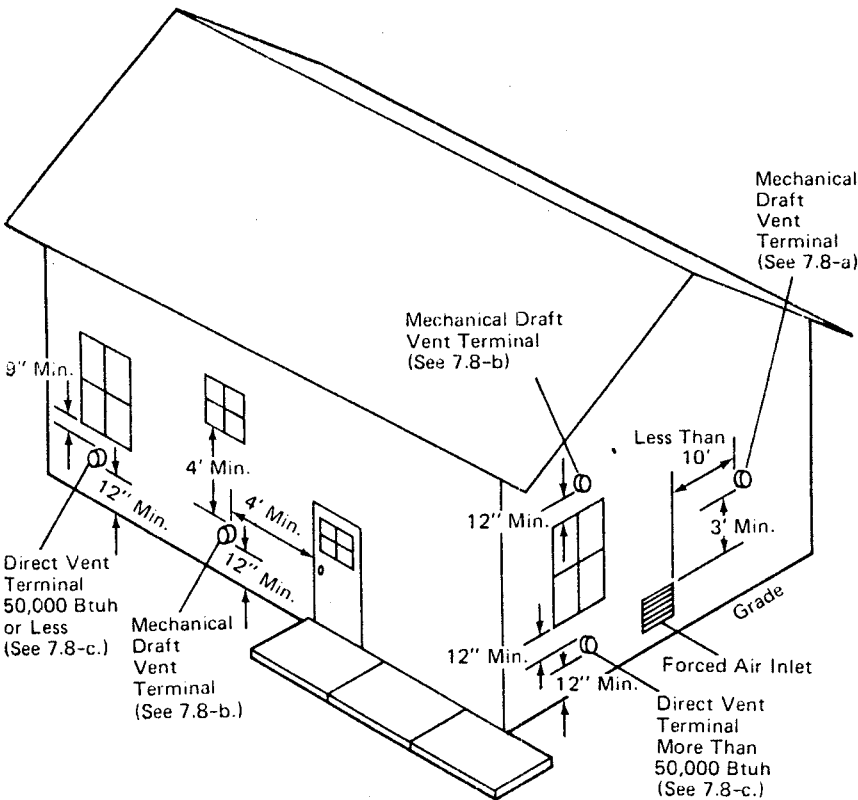

For SI units: 1 foot = 0.305 m; 1 inch = 2.54 cm; 1 Btu per hour = 0.293 watts

Figure A.7.8. Exit Terminals of Mechanical Draft and Direct Vent Venting Systems.

from the NATIONAL FUEL GAS CODE HANDBOOK

Maximum Capacity of Pipe in Cubic Feet of Natural Gas per Hour for Gas Pressures of 0.5 psig or Less and a Pressure Drop of 0.5 Inch Water Column

(Based on a 0.60 Specific Gravity Gas)

Nominal Iron Pipe Size, Inches	Internal Diameter, Inches	Length of Pipe, Feet															
		10	20	30	40	50	60	70	80	90	100	125	150	175	200		
1/4	.364	43	29	24	20	18	16	15	14	13	12	11	10	9	8		
3/8	.493	95	65	52	45	40	36	33	31	29	27	24	22	20	19		
1/2	.622	175	120	97	82	73	66	61	57	53	50	44	40	37	35		
3/4	.824	360	250	200	170	151	138	125	118	110	103	93	84	77	72		
1	1.049	680	465	375	320	285	260	240	220	205	195	175	160	145	135		
1 1/4	1.380	1,400	950	770	660	580	530	490	460	430	400	360	325	300	280		
1 1/2	1.610	2,100	1,460	1,180	990	900	810	750	690	650	620	550	500	460	430		
2	2.067	3,950	2,750	2,200	1,900	1,680	1,520	1,400	1,300	1,220	1,150	1,020	950	850	800		
2 1/2	2.469	6,300	4,350	3,520	3,000	2,650	2,400	2,250	2,050	1,950	1,850	1,650	1,500	1,370	1,280		
3	3.068	11,000	7,700	6,250	5,300	4,750	4,300	3,900	3,700	3,450	3,250	2,950	2,650	2,450	2,280		
4	4.026	23,000	15,600	12,800	10,900	9,700	8,800	8,100	7,500	7,200	6,700	6,000	5,500	5,000	4,600		

from the NATIONAL FUEL GAS CODE HANDBOOK

Table 10-26 Pipe Sizing
Sizing between Single or Second Stage (Low Pressure Regulator) and Appliance

Maximum undiluted propane capacities listed are based on 11 inch water column setting and a 0.5 inch water column pressure drop.

Capacities in 1000 Btu/hr

Pipe Length (Feet)	Nominal Pipe Size, Schedule 40								
	1/2"	3/4"	1"	1 1/4"	1 1/2"	2"	3"	3 1/2"	4"
	0.622	0.824	1.049	1.38	1.61	2.067	3.068	3.548	4.026
10	291	608	1146	2353	3525	6789	19130	28008	39018
20	200	418	788	1617	2423	4666	13148	19250	26817
30	161	336	632	1299	1946	3747	10558	15458	21535
40	137	287	541	1111	1665	3207	9036	13230	18431
50	122	255	480	985	1476	2842	8009	11726	16335
60	110	231	435	892	1337	2575	7256	10625	14801
80	94	198	372	764	1144	2204	6211	9093	12668
100	84	175	330	677	1014	1954	5504	8059	11227
125	74	155	292	600	899	1731	4878	7143	9950
150	67	141	265	544	815	1569	4420	6472	9016
200	58	120	227	465	697	1343	3783	5539	7716
250	51	107	201	412	618	1190	3353	4909	6839
300	46	97	182	374	560	1078	3038	4448	6196
350	43	89	167	344	515	992	2795	4092	5701
400	40	83	156	320	479	923	2600	3807	5303

Table 10-27 Copper Tube Sizing
Sizing between First Stage (High Pressure Regulator) and Second Stage (Low Pressure Regulator)

Maximum undiluted propane capacities listed are based on a 10 psi first stage setting and 1 psi drop.

Capacities in 1000 Btu/hr

Tubing Length (Feet)	Outside Diameter Copper Tubing, Type L				
	3/8"	1/2"	5/8"	3/4"	7/8"
	0.315	0.430	0.545	0.666	0.785
30	309	700	1303	2205	3394
40	265	599	1115	1887	2904
50	235	531	988	1672	2574
60	213	481	896	1515	2332
70	196	443	824	1394	2146
80	182	412	767	1297	1996
90	171	386	719	1217	1873
100	161	365	679	1149	1769
150	130	293	546	923	1421
200	111	251	467	790	1216
250	90	222	414	700	1078
300	89	201	375	634	976
350	82	185	345	584	898
400	76	172	321	543	836
450	71	162	301	509	784
500	68	153	284	481	741
600	61	138	258	436	671
700	56	127	237	401	617
800	52	118	221	373	574
900	49	111	207	350	539
1000	46	105	195	331	509
1500	37	84	157	266	409
2000	32	72	134	227	350

Table 10-28 Copper Tube Sizing
Sizing between Single or Second Stage (Low Pressure Regulator) and Appliance

Maximum undiluted propane capacities are based on 11 inch water column setting and a 0.5 inch water column pressure drop.

Capacities in 1000 Btu/hr

Tubing Length (Feet)	Outside Diameter Copper Tubing, Type L				
	3/8"	1/2"	5/8"	3/4"	7/8"
	0.315	0.430	0.545	0.666	0.785
10	49	110	206	348	536
20	34	76	141	239	368
30	27	61	114	192	296
40	23	52	97	164	253
50	20	46	86	146	224
60	19	42	78	132	203
80	16	36	67	113	174
100	14	32	59	100	154
125	12	28	52	89	137
150	11	26	48	80	124
200	10	22	41	69	106
250	9	19	36	61	94
300	8	18	33	55	85
350	7	16	30	51	78
400	7	15	28	47	73

Based on Propane Fuel NFPA #54, 1996 Edition

Information About LP-Gas *

	Propane	Butane
Formula	C_3H_8	C_4H_{10}
Boiling Point, °F	-44	32
Specific Gravity of Gas (Air= 1.00)	1.53	2.00
Specific Gravity of Liquid (Water= 1.00)	0.51	0.58
Lbs. per Gallon of Liquid at 60 °F	4.24	4.81
BTU per Gallon of Gas at 60 °F	91690	102032
BTU per Lb. of Gas	21591	21221
BTU per Cu. Ft. of Gas at 60 °F	2516	3280
Cu. Ft. of Vapor at 60 °F/Gal. of Liquid at 60 °F	36.39	31.26
Cu. Ft. of Vapor at 60 °F/Lb. of Liquid at 60 °F	8.547	6.506
Latent Heat of Vaporization at Boiling Point BTU/Gal.	785.0	808.0
Combustion Data:		
Cu. Ft. Air Required to Burn 1 Cu. Ft. Gas	23.86	31.02
Flash Point, °F	-156	N.A.
Ignition Temperature in Air, °F	920-1020	900-1000
Maximum Flame Temperature in Air, °F	3595	3615
Limits of Flammability, Percentage of Gas in Air Mixture;		
At Lower Limit—%	2.4	1.9
At Upper Limit—%	9.6	8.6
Octane Number (ISO-Octane=100)	Over 100	92

* Commercial quality. Figures shown in this chart represent average values.

Location of DOT Cylinders

From NFPA 58, Appendix G

Federal, state, and local ordinances and regulations should be observed at all times.

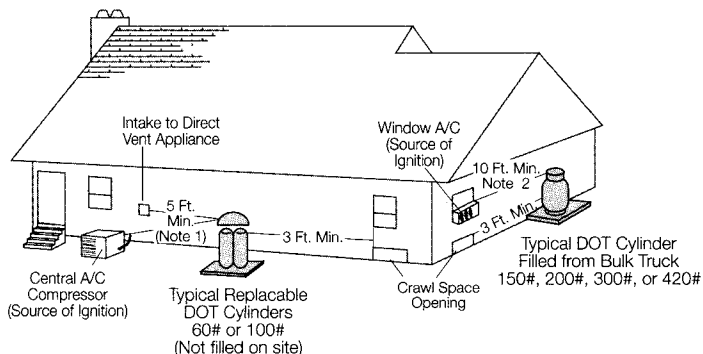

Notes: 1) 5 foot minimum between relief valve discharge and external source of ignition (air conditioner), direct vent, or mechanical ventilation system (attic fan).

2) If the DOT cylinder is filled on-site from a bulk truck, the filling connection and vent valve must be at least 10 feet from any external source of ignition, direct vent, or mechanical ventilation system.

TANKS
HOT WATER STORAGE TANKS AND GENERATORS

Size Inches	Capacity Gallons	Weight Pounds	Size Inches	Capacity Gallons	Weight Pounds
20 × 46"	53	165	48 × 104"	840	1750
20 × 58"	80	205	48 × 140"	1125	2240
24 × 47"	92	230	48 × 164"	1315	2560
24 × 59"	115	280	48 × 188"	1505	2900
24 × 71"	140	325	48 × 212"	1690	3200
24 × 83"	160	380	48 × 260"	2065	3870
30 × 60"	190	495	54 × 120"	1220	2740
30 × 72"	220	590	54 × 144"	1460	3200
30 × 84"	270	670	54 × 168"	1700	3650
30 × 96"	305	770	54 × 216"	2080	4570
30 × 120"	340	945	60 × 124"	1580	3400
30 × 132"	415	1030	60 × 148"	1870	3970
36 × 72"	350	800	60 × 196"	2450	5100
36 × 88"	400	880	60 × 220"	2740	5680
36 × 96"	450	990	60 × 280"	3465	7100
36 × 112"	500	1090	72 × 223"	3940	7120
36 × 136"	600	1300	72 × 319"	5630	9500
42 × 90"	580	1310	72 × 415"	7325	11700
42 × 102"	650	1460	84 × 168"	4040	9100
42 × 114"	720	1600	84 × 192"	4630	10000
42 × 138"	865	1900	96 × 174"	5400	11900
42 × 162"	1005	2180	96 × 198"	6660	12800
42 × 186"	1050	2460	96 × 246"	7680	15000

FUEL OIL TANKS (UL-LABEL)

Size Inches	Capacity Gallons	Weight Pounds	Size Inches	Capacity Gallons	Weight Pounds
30 × 90"	275	240	90 × 18'-0"	5948	5400
42 × 94"	560	350	90 × 20'-0"	6600	6800
48 × 65"	510	320	90 × 24'-0"	7900	7200
48 × 128"	1004	930	90 × 28'-0"	9254	8300
64 × 72"	1016	950	90 × 32'-0"	10576	9000
64 × 143"	1990	2000	120 × 16'-0"	9450	7400
64 × 17'-10"	2980	2900	120 × 20'-0"	11750	8700
64 × 23'-8"	3950	4100	120 × 24'-0"	14100	10000
90 × 12'-0"	3966	4200	120 × 28'-0"	16500	11000
90 × 16'-0"	5288	5100	120 × 32'-0"	18750	13000

CONVERSION FACTORS

MULTIPLY	BY	TO OBTAIN	MULTIPLY	BY	TO OBTAIN
Angstrom units	3.939×10^{10}	Inches	Calories (large)	3.968	British thermal units
Angstrom units	.0001	Microns	Calories (large)	1.1619	Watt-hours
Atmospheres	760.0	Millimeters of mercury (at 32 F)	Calories (large) per hour	3.968	Btu per hour
Atmospheres	29.921	Inches of mercury (at 32 F)	Calories (small) per cm. per sq. cm. per hr. per C	.00156	Horsepower
Atmospheres	33.97	Feet of water (at 62 F)	Centimeters	.8064	Btu per inch per sq. ft. per hr. per F
Atmospheres	10,333.0	Kilograms per square meter	Centimeters of mercury	0.3937	Inches
Atmospheres	14,697	Pounds per square inch	Centimeters of mercury	0.01316	Atmospheres
Atmospheres	4.211	Cubic feet	Centimeters of mercury	0.4461	Feet of water
Barrels (U.S. liquid)	31.5	Gallons	Centimeters of mercury	136.0	Kilograms per square meter
Barrels (U.S. liquid)	42	Btu per hour	Centimeters of mercury	27.85	Pounds per square foot
Boiler horsepower	33,475	Pounds water evaporated from and at 212 F	Centimeters of mercury	0.1934	Pounds per square inch
Boiler horsepower	34.5	Tons of refrigeration (U.S.)	Centimeters of mercury	0.06102	Cubic inches
British tons of refrigeration (commercial)	1.1045	Tons of refrigeration (U.S.)	Centimeters of mercury	0.0002642	Gallons
British tons of refrigeration (theoretical)	1.1905	Tons of refrigeration (U.S.)	Centimeters of mercury	.028317	Cubic meters
Btu	252	Calories (large)	Cubic feet	1,728.0	Cubic inches
Btu	.252	Calories (small)	Cubic feet	7.48052	Gallons
Btu	778	Foot pounds	Cubic feet	28.32	Liters
Btu	.000393	Horsepower hour	Cubic feet of water	62.37	Pounds (at 60 F)
Btu	.000293	Kilowatt hour	Cubic feet per minute	472.0	Cubic centimeters per sec.
Btu	.0010307	Pounds water evaporated from and at 212 F	Cubic feet per minute	0.1247	Gallons per second
Btu per 24 hours	347×10^{-5}	Tons of refrigeration	Cubic feet per minute	0.4720	Liters per second
Btu per hour	2986×10^{-4}	Boiler horsepower	Cubic inches	16.39	Cubic centimeters
Btu per hour	.252	Calories (large) per hour	Cubic meters	35.3145	Cubic feet
Btu per hour	.000393	Horsepower	Cubic meters	61,023.0	Cubic inches
Btu per hour	.000293	Kilowatts	Feet	264.2	Gallons
Btu per hour per square foot	.2712	Calories (small) per hour per square centimeter	Feet of water	30.48	Centimeters
Btu per hour per square foot per F	.488	Calories (small) per hour per square centimeter per C	Feet of water	0.3048	Meters
Btu per pound	.5556	Calories (large) per kilogram	Feet of water	0.881	Inches of mercury (at 32 F)
Btu per inch per square foot per inch per F	.0833	Btu per foot per sq. ft. per hour per F	Feet of water	304.8	Kilograms per square meter
Btu per inch per square foot per hour per F	1.24	Calories (small) per centimeter per sq. cm. per hr. per C	Feet of water	62.37	Pounds per square foot
			Feet of water	0.4335	Pounds per square inch
			Feet of water	0.5080	Centimeters per second
			Feet of water	0.01667	Feet per second
			Feet of water	0.3048	Meters per minute
			Feet of water	0.001286	British thermal units
			Feet of water	30.48	Centimeters per second
			Feet of water	18.29	Meters per minute
			Gallons (U.S.)	3,785.0	Cubic centimeters
			Gallons (U.S.)	0.1337	Cubic feet
			Gallons (U.S.)	231.0	Cubic inches
			Gallons (U.S.)	0.003785	Cubic meters
			Gallons (U.S.)	3.7853	Liters

MULTIPLY	BY	TO OBTAIN	MULTIPLY	BY	TO OBTAIN
Gallons of water	8.3453	Pounds of water (at 60F)	Meters per minute	3.281	Feet per minute
Gallons per minute	0.06308	Liters per second	Meters per second	196.8	Feet per second
Grams	15.432	Grains	Meters per second	3.281	Feet per second
Grains	.0648	Grams	Miles	1.60935	Kilometers
Horsepower	33,000.0	Foot pounds per minute	Pounds	7,000.0	Grains
Horsepower	2,546.0	British thermal units per hour	Pounds	0.45359	Kilograms
Horsepower	42.42	British thermal units per minute	Pounds of water (at 60F)	0.01602	Cubic feet
Horsepower	1.014	British thermal units per hour	Pounds of water (at 60F)	27.68	Cubic inches
Horsepower	0.7457	Horsepower (metric)	Pounds of water (at 60F)	0.1198	Gallons
Horsepower (boiler)	33,475	Kilowatts	Pounds of water (at 60F)	0.284	Kilowatt-hours
Inches	2.540	hour	Pounds of water evaporated from and at 212F	0.381	Horsepower hours
Inches of mercury (at 62F)	.03342	Centimeters	Pounds of water evaporated from and at 212F	970.4	British thermal units
Inches of mercury (at 62F)	13.57	Atmospheres	Pounds of water evaporated from and at 212F	4.883	Kilograms per square meter
Inches of mercury (at 62F)	1.131	Inches of water (at 62F)	Pounds per square foot	0.06804	Atmospheres
Inches of mercury (at 62F)	345.3	Kilograms per square meter	Pounds per square inch	2.309	Feet of water (at 62F)
Inches of mercury (at 62F)	70.73	Pounds per square foot	Pounds per square inch	2.0416	Inches of mercury (at 62F)
Inches of mercury (at 62F)	.4912	Pounds per square inch	Pounds per square inch	.0703	Kilograms per square centimeter
Inches of water (at 62F)	.002458	Atmospheres	Quarts	0.946	Liters
Inches of water (at 62F)	.07355	Inches of mercury	Square centimeters	.1550	Square inches
Inches of water (at 62F)	25.40	Kilograms per square meter	Square feet	.09290	Square centimeters
Inches of water (at 62F)	.03613	Pounds per square inch	Square feet	6.452	Square centimeters
Inches of water (at 62F)	5.202	Pounds per square foot	Square inches	10.765	Square feet
Kilograms	2.20462	Pounds	Square meters	1	Absolute temperature (C)
Kilogram-calories	3.968	British thermal units	Temperature (C) + 273	1.8	Temperature (F)
Kilograms per sq. cm.	14.220	Pounds per square inch	Temperature (C) + 17.78	1	Absolute temperature (F)
Kilograms per sq. meter	.2048	Pounds per square foot	Temperature (F) + 460	5-9	Temperature (C)
Kilometers	62137	Miles	Tons of refrigeration	12,000.0	British thermal units per hour
Kilowatts	56.92	British thermal units per minute	Tons of refrigeration	200.0	British thermal units per minute
Kilowatts	1.341	Horsepower	Watts	3.415	British thermal units per hour
Kilowatt-hours	3,415.0	British thermal units	Watts	0.05692	British thermal units per minute
Kilowatt-hours	860.5	Kilogram-calories	Watts	0.01434	British thermal units per minute
Latent heat of ice	143.33	British thermal units per pound	Watt-hours	3.415	Kilogram-calories per min.
Liters	0.03531	Cubic feet	Watt-hours	0.8605	Kilogram-calories
Liters	61.02	Cubic inches			
Liters	0.2642	Gallons			
Meters	3.28083	Feet			
Meters	39.37	Inches			
Meters	1.094	Yards			

CIRCLES

Circumferences and Areas

Dia.	Circum.	Area	Dia.	Circum.	Area	Dia.	Circum.	Area
1/32	.09818	.00077	8	25.133	50.265	21	65.973	346.36
1/16	.19635	.00307	1/8	25.525	51.849	1/4	66.759	354.66
1/8	.39270	.01227	1/4	25.918	53.456	1/2	67.544	363.05
3/16	.58905	.02761	3/8	26.311	55.088	3/4	68.330	371.54
1/4	.78540	.04909	1/2	26.704	56.745	22	69.115	380.13
5/16	.98175	.07670	5/8	27.096	58.426	1/4	69.900	388.82
3/8	1.1781	.11045	3/4	27.489	60.132	1/2	70.686	397.61
7/16	1.3744	.15033	7/8	27.882	61.862	3/4	71.471	406.49
1/2	1.5708	.19635	9	28.274	63.617	23	72.257	415.48
9/16	1.7671	.24850	1/8	28.667	65.397	1/4	73.042	424.56
5/8	1.9635	.30680	1/4	29.060	67.201	1/2	73.827	433.74
11/16	2.1598	.37122	3/8	29.452	69.029	3/4	74.613	443.01
3/4	2.3562	.44179	1/2	29.845	70.882	24	75.398	452.39
13/16	2.5525	.51849	5/8	30.238	72.760	1/4	76.184	461.86
7/8	2.7489	.60132	3/4	30.631	74.662	1/2	76.969	471.44
15/16	2.9452	.69029	7/8	31.023	76.589	3/4	77.754	481.11
1	3.1416	.7854	10	31.416	78.540	25	78.540	490.87
1/8	3.5343	.9540	1/8	31.809	80.516	1/2	80.111	510.71
1/4	3.9270	1.2272	1/4	32.201	82.516	26	81.681	530.93
3/8	4.3197	1.4849	3/8	32.594	84.541	1/2	83.252	551.55
1/2	4.7124	1.7671	1/2	32.987	86.590	27	84.823	572.56
5/8	5.1051	2.0739	5/8	33.379	88.664	1/2	86.394	593.96
3/4	5.4978	2.4053	3/4	33.772	90.763	28	87.965	615.75
7/8	5.8905	2.7612	7/8	34.165	92.886	1/2	89.535	637.94
2	6.2832	3.1416	11	34.558	95.033	29	91.106	660.52
1/8	6.6759	3.5466	1/8	34.950	97.205	1/2	92.677	683.49
1/4	7.0686	3.9761	1/4	35.343	99.402	30	94.248	706.86
3/8	7.4613	4.4301	3/8	35.736	101.62	1/2	95.819	730.62
1/2	7.8540	4.9087	1/2	36.128	103.87	31	97.389	754.77
5/8	8.2467	5.4119	5/8	36.521	106.14	1/2	98.960	779.31
3/4	8.6394	5.9396	3/4	36.914	108.43	32	100.531	804.25
7/8	9.0321	6.4918	7/8	37.306	110.75	1/2	102.102	829.58
3	9.4248	7.0686	12	37.699	113.10	33	103.673	855.30
1/8	9.8175	7.6699	1/8	38.092	115.47	1/2	105.243	881.41
1/4	10.210	8.2958	1/4	38.485	117.86	34	106.814	907.92
3/8	10.603	8.9462	3/8	38.877	120.28	1/2	108.385	934.82
1/2	10.996	9.6211	1/2	39.270	122.72	35	109.956	962.11
5/8	11.388	10.321	5/8	39.663	125.19	1/2	111.527	989.80
3/4	11.781	11.045	3/4	40.055	127.68	36	113.097	1017.9
7/8	12.174	11.793	7/8	40.448	130.19	1/2	114.668	1046.3
4	12.566	12.566	13	40.841	132.73	37	116.239	1075.2
1/8	12.959	13.364	1/4	41.234	135.29	1/2	117.810	1104.5
1/4	13.352	14.186	1/2	41.626	137.87	38	119.381	1134.1
3/8	13.744	15.033	3/4	42.018	140.47	1/2	120.951	1164.2
1/2	14.137	15.904	14	42.410	143.08	39	122.522	1194.6
5/8	14.530	16.800	1/4	42.802	145.70	1/2	124.093	1225.4
3/4	14.923	17.721	1/2	43.194	148.34	40	125.664	1256.6
7/8	15.315	18.665	3/4	43.586	151.00	1/2	127.235	1288.2
5	15.708	19.635	15	43.978	153.67	41	128.806	1320.3
1/8	16.101	20.629	1/4	44.370	156.36	1/2	130.376	1352.7
1/4	16.493	21.648	1/2	44.762	159.06	42	131.947	1385.6
3/8	16.886	22.691	3/4	45.154	161.78	43	133.517	1418.6
1/2	17.279	23.758	16	45.546	164.51	1/2	135.088	1452.2
5/8	17.671	24.850	1/4	45.938	167.26	44	136.659	1486.2
3/4	18.064	25.967	1/2	46.330	170.02	1/2	138.230	1520.5
7/8	18.457	27.109	3/4	46.722	172.79	45	139.801	1555.3
6	18.850	28.274	17	47.114	175.57	1/2	141.372	1590.4
1/8	19.242	29.465	1/4	47.506	178.37	46	142.943	1626.0
1/4	19.635	30.680	1/2	47.898	181.18	1/2	144.513	1661.9
3/8	20.028	31.919	3/4	48.290	184.00	47	146.084	1698.2
1/2	20.420	33.183	18	48.682	186.83	1/2	147.655	1734.9
5/8	20.813	34.472	1/4	49.074	189.68	48	149.226	1772.1
3/4	21.206	35.785	1/2	49.466	192.54	1/2	150.796	1809.6
7/8	21.598	37.122	3/4	49.858	195.41	49	152.367	1847.5
7	21.991	38.485	19	50.250	198.30	1/2	153.938	1885.7
1/8	22.384	39.871	1/4	50.642	201.20	50	155.509	1924.4
1/4	22.776	41.282	1/2	51.034	204.11		157.080	1963.5
3/8	23.169	42.718	3/4	51.426	207.03			
1/2	23.562	44.179	20	51.818	210.00			
5/8	23.955	45.664	1/4	52.210	213.00			
3/4	24.347	47.173	1/2	52.602	216.00			
7/8	24.740	48.707	3/4	52.994	219.00			

Circumference = $2\pi r = \pi d$

Area = $\pi r^2 = \frac{\pi d^2}{4}$

CONTENTS IN CUBIC FEET U.S. GALLONS OF PIPES AND CYLINDERS

Diam. in Inches	For 1 Foot in Length		Diam. in Inches	For 1 Foot in Length		Diam. in Inches	For 1 Foot in Length	
	Cubic Feet	U.S. Gallons		Cubic Feet	U.S. Gallons		Cubic Feet	U.S. Gallons
1/4	0.0003	0.0025	6-3/4	0.2485	1.859	19	1.969	14.73
5/16	0.0005	0.0040	7	0.2673	1.999	19-1/2	2.074	15.51
3/8	0.0008	0.0057	7-1/4	0.2867	2.145	20	2.182	16.32
7/16	0.0010	0.0078	7-1/2	0.3068	2.295	20-1/2	2.292	17.15
1/2	0.0014	0.0102	7-3/4	0.3276	2.450	21	2.405	17.99
9/16	0.0017	0.0129	8	0.3491	2.611	21-1/2	2.521	18.86
5/8	0.0021	0.0159	8-1/4	0.3712	2.777	22	2.640	19.75
11/16	0.0026	0.0193	8-1/2	0.3941	2.948	22-1/2	2.761	20.66
3/4	0.0031	0.0230	8-3/4	0.4176	3.125	23	2.885	21.58
13/16	0.0036	0.0269	9	0.4418	3.305	23-1/2	3.012	22.53
7/8	0.0042	0.0312	9-1/4	0.4667	3.491	24	3.142	23.50
15/16	0.0048	0.0359	9-1/2	0.4922	3.682	25	3.409	25.50
1	0.0055	0.0408	9-3/4	0.5185	3.879	26	3.687	27.58
1-1/4	0.0085	0.0638	10	0.5454	4.080	27	3.976	29.74
1-1/2	0.0123	0.0918	10-1/4	0.5730	4.286	28	4.276	31.99
1-3/4	0.0167	0.1249	10-1/2	0.6013	4.498	29	4.587	34.31
2	0.0218	0.1632	10-3/4	0.6303	4.715	30	4.909	36.72
2-1/4	0.0276	0.2066	11	0.6600	4.937	31	5.241	39.21
2-1/2	0.0341	0.2550	11-1/4	0.6903	5.164	32	5.585	41.78
2-3/4	0.0412	0.3085	11-1/2	0.7213	5.396	33	5.940	44.43
3	0.0491	0.3672	11-3/4	0.7530	5.633	34	6.305	47.16
3-1/4	0.0576	0.4309	12	0.7854	5.875	35	6.681	49.98
3-1/2	0.0668	0.4998	12-1/2	0.8522	6.375	36	7.069	52.88
3-3/4	0.0767	0.5738	13	0.9218	6.895	37	7.467	55.86
4	0.0873	0.6528	13-1/2	0.9940	7.436	38	7.876	58.92
4-1/4	0.0985	0.7369	14	1.069	7.997	39	8.296	62.06
4-1/2	0.1104	0.8263	14-1/2	1.147	8.578	40	8.727	65.28
4-3/4	0.1231	0.9206	15	1.227	9.180	41	9.168	68.58
5	0.1364	1.020	15-1/2	1.310	9.801	42	9.621	71.97
5-1/4	0.1503	1.125	16	1.396	10.44	43	10.085	75.44
5-1/2	0.1650	1.234	16-1/2	1.485	11.11	44	10.559	78.99
5-3/4	0.1803	1.349	17	1.576	11.79	45	11.045	82.62
6	0.1963	1.469	17-1/2	1.670	12.49	46	11.541	86.33
6-1/4	0.2131	1.594	18	1.767	13.22	47	12.048	90.13
6-1/2	0.2304	1.724	18-1/2	1.867	13.96	48	12.566	94.00

One cubic foot of water at 39.1 degrees F. weighs 62.4245 pounds.
 One cubic foot of air at 32 degrees F., atmospheric pressure, weighs 0.08073 pound.
 One pound of water at 39.1 degrees F. has a volume of 0.01602 cubic foot.
 One pound of air at 32 degrees F., atmospheric pressure, has a volume of 12.387 cubic feet.
 One gallon of water at 62 degrees F. weighs 8.336 pounds.
 One pound of water at 62 degrees F. has a volume of 0.1199 U.S. gallon.

ZONING MADE EASY

RULES OF THUMB

FLOW RATE

$$\frac{\text{Net Btuh Load}}{10,000} = \text{Flow Rate}$$

MAXIMUM FLOW RATE

Pipe Size (Copper)	Maximum Flow Rate
1/2"	1 1/2 gpm
3/4"	4 gpm
1"	8 gpm
1 1/4"	14 gpm

MAXIMUM FLOW RATE & HEAT CARRYING CAPACITY

Pipe Size (Copper)	Maximum Flow Rate	Heat Carrying Capacity
1/2"	1 1/2 gpm	15,000 Btuh
3/4"	4 gpm	40,000 Btuh
1"	8 gpm	80,000 Btuh
1 1/4"	14 gpm	140,000 Btuh

(Based on a 20-degree temperature drop across the system)

MAXIMUM LENGTH OF FIN-TUBE BASEBOARD LOOP

Baseboard Size Size (Copper)	Typical Btuh Per Linear Foot	Maximum Length of Baseboard Loop
1/2"	600	25 feet
3/4"	600	67 feet
1"	770	104 feet
1 1/4"	790	177 feet

(Based on 180-degree average water temperature and a 20-degree temperature drop across the system)

"PUMP HEAD"

1. Measure the longest run in feet.
3. Multiply that by .04, and
2. Add 50% to this.
4. That's the pump head!

CHAPTER 4 - INSTALLED RADIATION: DETERMINING HEAT LOAD

HEAT LOSSES FROM BARE STEEL PIPE

Based On 70° Surrounding Air

Diameter of Pipe, Inches	Temperature of Pipe, Deg. F					
	100	120	150	180	210	240
	Heat Loss per Lineal Foot of Pipe, BTU per Hour					
1/2	13	22	40	60	82	106
3/4	15	27	50	74	100	131
1	19	34	61	90	123	160
1¼	23	42	75	111	152	198
1½	27	48	85	126	173	224
2	33	59	104	154	212	275
2½	39	70	123	184	252	327
3	46	84	148	221	303	393
3½	52	95	168	250	342	444
4	59	106	187	278	381	496
5	71	129	227	339	464	603
6	84	151	267	398	546	709
8	107	194	341	509	697	906
10	132	238	420	626	857	1114
12	154	279	491	732	1003	1305
14	181	326	575	856	1173	1527
16	203	366	644	960	1314	1711
18	214	385	678	1011	1385	1802
20	236	426	748	1115	1529	1990

HEAT LOSSES FROM BARE TARNISHED COPPER TUBE

Based On 70° Surrounding Air

Diameter of Pipe, Inches	Temperature of Pipe, Deg. F					
	100	120	150	180	210	240
	Heat Loss per Lineal Foot of Pipe, BTU per Hour					
1/4	4	8	14	21	29	37
3/8	6	10	18	28	37	48
1/2	7	13	22	33	45	59
5/8	8	15	26	39	53	68
3/4	9	17	30	45	61	79
1	11	21	37	55	75	97
1¼	14	25	45	66	90	117
1½	16	29	52	77	105	135
2	20	37	66	97	132	171
2½	24	44	78	117	160	206
3	28	51	92	136	186	240
3½	32	59	104	156	212	274
4	36	66	118	174	238	307
5	43	80	142	212	288	373
6	51	93	166	246	336	432
8	66	120	215	317	435	562
10	80	146	260	387	527	681
12	94	172	304	447	621	802

RADIATOR RATINGS

The output of a radiator is measured in square feet of direct radiation. To determine the number of square feet of direct radiation in a radiator

1. Identify the style of radiator—See Fig. 1 below.
2. Measure the height and width of the radiator.
3. Count the number of tubes in a section.
4. Count the number of sections.
5. Determine the square feet of radiation per section from the appropriate table and multiply by the number of sections.

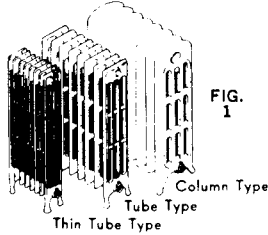

FIG. 1

Fig. 1 shows the relative sizes of radiator styles. All are four tube, eight section radiators but each rating is different.

EXAMPLE

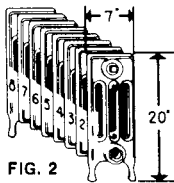

FIG. 2





Fig. 2 shows a tube type radiator, 20" high by 7" wide. There are four tubes per section and eight sections. The table on page four shows this size radiator has $2\frac{1}{4}$ square feet of radiation per section. $2\frac{1}{4}$ times 8 (the number of sections) equals 18 square feet of direct radiation in the radiator.

NOTE: All radiator dimensions and ratings in this booklet are approximate. Ratings should be used for checking the total radiation connected to an existing boiler.





OLD STYLE COLUMN RADIATORS SQ. FT. OF RADIATION PER SECTION

	NO. OF COLUMNS					
	1	2	3	4	5	6
Width →	4½"	7¾"	9"	11½"	12½"	12½"
Height In.						
45"	3½	5	6	10	—	—
38"	3	4	5	8	10	—
32"	2½	3⅓	4½	5½	8½	—
26"	2	2⅔	3¾	5	7	7
23"	1⅔	2⅓	3¼	4½	—	—
22"	1⅔	2¼	3	4	6	6
20"	1½	2	2¾	3½	5	5
18"	1⅓	1¾	2¼	3	5	4⅓
17"	—	—	—	—	—	4
16"	—	—	—	—	4	3¾
15"	—	1½	—	—	—	—
14"	—	—	—	—	4	3
13"	—	—	—	—	3	3

TUBE TYPE RADIATORS
SQ. FT. OF RADIATION PER SECTION

		NO. OF TUBES				
		3	4	5	6	7
Width→		 5"	 7"	 8¾"	 9¾"	 12½"
Height In.						
38"		3½	4¼	5	6	—
36"		3½	4¼	5	6	7
32"		3	3½	4½	5	6
26"		2⅓	2¾	3½	4	5
23"		2	2½	3	3½	4½
22"		—	—	—	—	4½
20"		1¾	2¼	2⅔	3	3⅔
18"		—	—	—	—	3½
17"		—	—	—	—	3
16"		—	—	—	—	3
14"		—	—	—	—	2½

THIN TUBE RADIATORS
SQ. FT. OF RADIATION PER SECTION

		NO. OF TUBES				
		2	3	4	5	6
Width→		 3½"	 4"	 4¾"	 6"	 7⅞"
Height In.						
38"		2.5	2.6	—	—	—
32"		2.0	2.4	—	—	3.7
26"		—	—	2.4	3.0	3.0
25"		1.6	1.6	2.0	—	3.0
23"		—	—	—	2.1	—
22"		1.3	1.4	1.8	—	—
20"		—	—	1.8	—	2.3
19"		1.1	1.2	1.6	—	2.3
17"		—	—	—	2.0	—

WALL TYPE RADIATORS

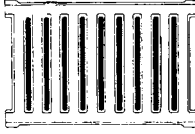

Size	Sq. Ft. Per Radiator
13½" x 17" x 3"	5
13½" x 21" x 3"	6
13½" x 22" x 3"	7
13½" x 29" x 3"	9

SECTIONAL WALL TYPE RADIATORS

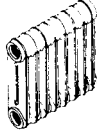

Height	37"	26½"	21½"	15"	13⅞"
Sq. Ft. Radiation Per Section	2½	1¾	1½	1	¾

RADIATOR RATING STANDARDS

A SQUARE FOOT OF STEAM RADIATION is based on a heat emission of 240 BTU per hour per square foot, with standard 70° F. air temperature and 215° F. steam temperature in the radiator. A SQUARE FOOT OF WATER RADIATION is based on a heat emission of 150 BTU per hour per square foot, with standard 70° F. air temperature and an average water temperature in the radiator of 170° F.

A different rate of heat emission will be obtained when the average water temperature in the radiator is higher or lower than 170° F. See table below.

EXAMPLE: A structure has a calculated heat loss of 63,000 BTU and an average water temperature in the radiators of 200° F. As shown in the heat emission table, with 200° F. average water temperature, the heat emission is 210 BTU per square foot of radiation. Therefore the footage which must be used in selecting radiators is 300 sq. ft. (63,000 ÷ 210 = 300). Select the boiler on 63,000 BTU net rating.

HEAT EMISSION based on Room Temperature of 70° F.

AVERAGE WATER TEMP. IN RADIATORS °F							
150	160	170	180	190	200	210	215
HEAT EMISSION BTU PER HOUR SQ. FT.							
110	130	150	170	190	210	230	240

WEIL-McLAIN BASEBOARD RADIATION RATINGS

Capacities per Lineal Foot in BTU/Hr. with 65° F. Entering Air

CAST IRON BASEBOARD

MODEL	STEAM RATING SQ. FT. STEAM @ 215° F.	WATER FLOW RATE — 500 LBS./HR. OR 1 GPM						
		AVERAGE WATER TEMPERATURE BETWEEN INLET AND OUTLET — °F.						
		150	160	170	180	190	200	215
No. 9	3.35	390	450	510	570	640	700	800

CONVECTOR BASEBOARD

MODEL	WATER FLOW RATE — 500 LBS./HR. OR 1 GPM							
	AVERAGE WATER TEMPERATURE BETWEEN INLET AND OUTLET — °F.							
	170	180	190	200	210	220	230	240
Model 75 WL-3 (¾" Tube)								
THERMA TRIM	530	600	670	740	810	870	—	—
Model 75 H (¾" Tube)								
HIGH TRIM	680	760	850	940	1,030	1,110	1,200	1,290

CHAPTER 5 - WATER CONTENT EXISTING RADIATION/PIPING

A. RADIATION:

Based on Sq. Ft. Rating	Water Content/Gal.	Weight/Lbs.
Slenderized Radiators	0.066	4.5
Large Tube Radiators	0.103	5.25
Column Radiators	0.188	7.0
Convectors (Non-Ferrous)	0.004	1.5
Convectors (Cast Iron)	0.04	3.4
Radiant Radiators	0.066	5.0
Base-Ray (Cast Iron Baseboard)	0.066	4.4

B. STEEL AND WROUGHT IRON PIPE (STD. WGT.)

Nominal Size: Inches	Based On Lineal Foot	
	Water Content/Gal.	Weight/Lbs.
1/2"	.016	.132
3/4"	.028	.231
1"	.045	.375
1 1/4"	.078	.648
1 1/2"	.106	.883
2"	.174	1.455
2 1/2"	.249	2.076
3"	.384	3.205
4"	.661	5.519
5"	1.039	8.662
6"	1.501	12.510

C. COPPER TUBING (TYPE L)

Nominal Size: Inches	Based on Lineal Foot	
	Water Content/Gal.	Weight/Lbs.
3/8"	.007	.063
1/2"	.012	.101
5/8"	.018	.151
3/4"	.025	.210
1"	.043	.357
1 1/4"	.065	.544
1 1/2"	.092	.770
2"	.161	1.340

D. WATER CONVERSION FACTORS

Lbs. of Water x 0.12 = Gallons

Gallons of Water x 8.33 = Lbs.

Lbs. of Water x 27.68 = Cubic Inches

Gallons of Water x 231 = Cubic Inches

Cubic Inches + 1728 = Cubic Feet

CHAPTER 7 - FUEL CONSUMPTION AND ENERGY COST

There are several ways to calculate the operational cost of a specific boiler in a particular location. The accuracy of each will depend on the attention one gives the many variables.

Two popular methods are the "bin" and "degree-day". Though the "bin" method has the potential to be more accurate, it is more complicated and necessary weather data is not readily available. Discussion will be limited to the "Degree-Day" method.

The "Degree-Day" method is not without controversy. Historically, the reference temperature is 65°. This assumes that a building with average insulation and a thermostat set at 70° will cause a boiler to begin operation when outdoor temperature falls below 65°. Overlooked variables could be sunshine, wind, heavier insulation, different thermostat setting.

WHAT IS A DEGREE DAY?

When the outside temperature falls below 65°F, heat will be required to maintain the temperature within the building. The average outside temperature is estimated by adding the high and low temperature for a given day and dividing by two. (Example: A high of 40°F and a low of 20°F would be equivalent to a 30°F average temperature.) "Degree Days" are defined as the difference between the average temperature and the 65°F reference temperature. Therefore, 65°F minus 30°F equals 35 "Degree Days".

$$\text{Degree Days} = 65 - (\text{high} + \text{low}) \div 2$$

FUEL CONSUMPTION

In order to determine fuel usage the D.D. is used in the following equation:

$$\frac{F = HL \times 24 \times DD}{E \times P \times T.D.}$$

HL	=	Heating Load (Btuh)
DD	=	Degree Day
24	=	Hours in a day
E	=	Boiler Efficiency (AFUE)
P	=	Heating value of fuel (Btu)
T.D.	=	Design temperature difference (inside-outside)
F	=	Annual fuel consumption

The Wind Chill Factor

Simple air temperature is not a reliable indicator of how we may feel outdoors. Other weather elements such as humidity, sunshine and wind speed all influence the "real" temperature. How do you measure wind speed without an instrument? Roughly, a wind speed up to 12 mph puts leaves in motion and can just be felt on the face . . . 13-24 mph moves small branches, raises dust, etc. . . . 25-30 mph makes wires whistle and moves large branches . . . 30-40 mph makes whole trees move and is difficult to walk against. This chart shows you must never underestimate the effect of the wind on outside temperatures. Obviously, winds also have relative effects on inside temperatures.

Wind Chill Chart

		Wind in Miles Per Hour									
		5	10	15	20	25	30	35	40	45	50
Current Temperature	35	33	21	16	12	7	5	3	1	1	0
	30	27	16	11	3	0	-2	-4	-4	-6	-7
	25	21	9	1	-4	-7	-11	-13	-15	-17	-17
	20	16	2	-6	-9	-15	-18	-20	-22	-24	-24
	15	12	-2	-11	-17	-22	-26	-27	-29	-31	-31
	10	7	-9	-18	-24	-29	-33	-35	-36	-38	-38
	5	1	-15	-25	-32	-37	-41	-43	-45	-46	-47
	0	-6	-22	-33	-40	-45	-49	-52	-54	-54	-56
	-5	-11	-27	-40	-46	-52	-56	-60	-62	-63	-63
	-10	-15	-31	-45	-52	-58	-63	-67	-69	-70	-70
	-15	-20	-38	-51	-60	-67	-70	-72	-76	-78	-79
	-20	-26	-45	-60	-68	-75	-78	-83	-87	-87	-88
	-25	-31	-52	-65	-76	-83	-87	-90	-94	-94	-96
	-30	-35	-58	-70	-81	-89	-94	-98	-101	-101	-103
	-35	-41	-64	-78	-88	-96	-101	-105	-107	-108	-110
-40	-47	-70	-85	-96	-104	-109	-113	-116	-118	-120	
-45	-54	-77	-90	-103	-112	-117	-123	-128	-128	-128	

**Radiant Panel Association
QUICK REFERENCE SHEET
to RPA Guidelines for Hydronic Radiant Floor Heating**

Special Insulation Considerations:

	Application	Min. R-Value	Coverage/Comment
Slab on Grade	Alternate #1	*(Ti-To) 0.125	perimeter to below frost line 4' horizontal or vertical at perimeter under entire slab
	Alternate #2	R-10	
	Conductive Soil	R-10	
Suspended Floors Over Heated Space	Hard Surface	R-9	under entire floor w/ 2" air gap
	Carpeted Surface	R-13	under entire floor w/ 2" air gap
Over Unheated Space	Hard Surface	R-13	under entire floor w/ 2" air gap
	Carpeted Surface	R-19	under entire floor w/ 2" air gap
Walls With Panels	outside wall	R-13	entire wall
	inside wall	optional	
Ceiling With Panels	inside ceiling	R-11	entire ceiling above panel
	outside ceiling	R-30	entire ceiling above panel

*R-value = Inside Temperature - Outdoor Temperature x 0.125

Pressure Testing Embedded Tubing - 100 PSI for at least 30 minutes

Floor Surface Temperatures - 85°F max. in prolonged foot contact areas
90°F max. other than prolonged foot contact areas
85°F max. on solid or laminated hardwood flooring

Fluid Temperatures - 140° max. in gypsum based thermal mass
160° max. underside of wood subfloor
180° max. underside of wood subfloor when approved by
tubing manufacturer's design methods

Floor Covering - R-value not to exceed design requirement

Tube Placement -

- Structural Slab 2" min. below surface, no tube joints in slab,
sleeved a min. of 4" either side of expansion joint
- Non-structural 3/4" underlayment over highest point in tube
1/8" min. gap between butt ends of aluminum plates
no inaccessible tube joints
- Joist Space 1/8" min. gap between butt ends of aluminum plates
2" air gap below tube except where aluminum plates are used

Tube Length -

<u>Tube Size</u>	<u>Recommended</u>	<u>Maximum</u>
1/4" I.D. tubing	100 ft.	125 ft.
3/8" I.D. tubing	200 ft.	250 ft.
1/2" I.D. tubing	250 ft.	350 ft.
5/8" I.D. tubing	400 ft.	500 ft.
3/4" I.D. tubing	500 ft.	600 ft.
1" I.D. tubing	750 ft.	750 ft.

Oxygen Permeation - Oxygen barrier tube, less than 0.1 gram/m³/day at 40°
Three options Heat Exchanger to isolate non-oxygen barrier tube
Water treatment to inhibit corrosion due to oxygen

Location of ASME Containers

From NFPA 58, Appendix G

Federal, state, and local ordinances and regulations should be observed at all times.

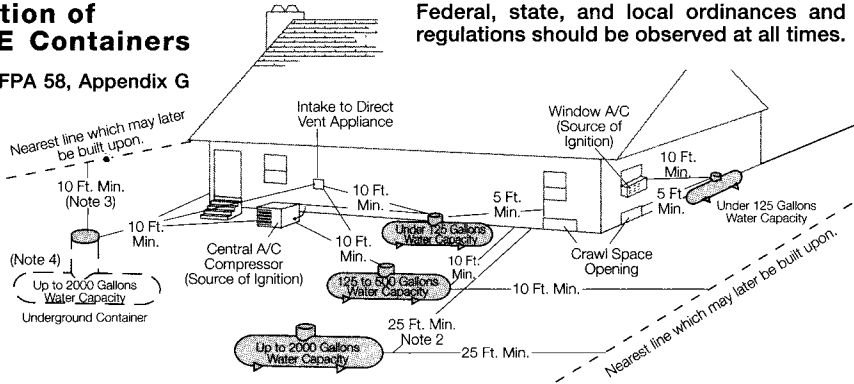

Notes:

- 1) Regardless of its size, any ASME tank filled on-site must be located so that the filling connection and fixed liquid level gauge are at least 10 feet from external source of ignition (i.e. open flame, window A/C, compressor, etc.), intake to direct vented gas appliance or intake to a mechanical ventilation system.
- 2) May be reduced to 10 feet minimum for a single container of 1200 gallons water capacity or less if it is located at least 25 feet from any other LP-Gas container of more than 125 gallons water capacity.
- 3) Minimum distances from underground containers shall be measured from the relief valve and filling or level gauge vent connection at the container, except that no part of an underground container shall be less than 10 feet from a building or line of adjoining property which may be built upon.
- 4) Where the container may be subject to abrasive action or physical damage due to vehicular traffic or other causes, it must be either a) placed not less than 2 feet below grade; b) otherwise protected against such physical damage.

Table 4 — Second, Single, or Integral Twin Stage Pipe Sizing

11 Inches Water Column Inlet with a 1/2 Inch Water Column Drop
 Maximum capacity of pipe or tubing in thousands of BTU/hr of LP-Gas

Size of Pipe or Copper Tubing, Inches	Length of Pipe or Tubing, Feet *									
	10	20	30	40	50	60	70	80	90	100
Copper Tubing (O.D.)										
3/8	49	34	27	23	20	19	—	—	—	—
1/2	110	76	61	52	46	42	38	36	33	32
5/8	206	141	114	97	86	78	71	67	62	59
3/4	348	239	192	164	146	132	120	113	105	100
7/8	536	368	296	253	224	203	185	174	161	154
Pipe Size										
1/2	291	200	161	137	122	110	102	94	87	84
3/4	608	418	336	287	255	231	212	198	185	175
1	1146	788	632	541	480	435	400	372	349	330
1-1/4	2353	1617	1299	1111	985	892	821	764	717	677
1-1/2	3525	2423	1946	1665	1476	1337	1230	1144	1074	1014
2	6789	4666	3747	3207	2842	2575	2369	2204	2068	1954

	125	150	175	200	225	250	275	300	350	400
Copper Tubing (O.D.)										
3/8	—	—	—	—	—	—	—	—	—	—
1/2	—	—	—	—	—	—	—	—	—	—
5/8	—	—	—	—	—	—	—	—	—	—
3/4	—	—	—	—	—	—	—	—	—	—
7/8	—	—	—	—	—	—	—	—	—	—
Pipe Size										
1/2	74	67	62	58	54	51	48	46	43	40
3/4	155	141	129	120	113	107	101	97	89	83
1	292	265	244	227	213	201	191	182	167	156
1-1/4	600	544	500	465	437	412	392	374	344	320
1-1/2	899	815	749	697	654	618	587	560	515	479
2	1731	1569	1443	1343	1260	1190	1130	1078	992	923

* Total length of piping from outlet of regulator to appliance furthest away.

Data Calculated per NFPA #54 & 58.

LIQUEFIED PETROLEUM GAS CODE

Table 12.14 Maximum Capacity of CSST in Thousands of Btu per Hour of Undiluted Liquefied Petroleum Gases at a Pressure of 11-in. Water Column and a Pressure Drop of 0.5-in. Water Column (based on a 1.52 specific gravity gas)

Size of Pipe or Copper Tubing, Inches	EHD* Flow Designation	Tubing Length, ft																
		5	10	15	20	25	30	40	50	60	70	80	90	100	150	200	250	300
3/8	13	72	50	39	34	30	28	23	20	19	17	15	15	14	11	9	8	8
3/8	15	99	69	55	49	42	39	33	30	26	25	23	22	20	15	14	12	11
3/8	18	181	129	104	91	82	74	64	58	53	49	45	44	41	31	28	25	23
1/2	19	211	150	121	106	94	87	74	66	60	57	52	50	47	36	33	30	26
1/2	23	355	254	208	183	164	151	131	118	107	99	94	90	85	66	60	53	50
3/4	25	426	303	248	216	192	177	153	137	126	117	109	102	98	75	69	61	57
1	30	744	521	422	365	325	297	256	227	207	191	178	169	159	123	112	99	90
1	31	863	605	490	425	379	344	297	265	241	222	208	197	186	143	129	117	107

Note: Table includes losses for four 90-degree bends and two end fittings. Tubing runs with larger numbers of bends or fittings shall be increased by an equivalent length of tubing to the following equation: $L = 1.3n$ where L is additional length (ft) of tubing and n is the number of additional fittings or bends.

*EHD — equivalent hydraulic diameter — a measure of the relative hydraulic efficiency between different tubing sizes. The greater the value of EHD, the greater the gas capacity of the tubing.

Source: NFPA 54, *National Fuel Gas Code*, 1999 edition, Table 9.29.

307.2 Cutting, notching or bored holes. A framing member shall not be cut, notched or bored in excess of limitations specified in the *International Building Code*.

❖ Cutting, notching or hole boring of structural members should be avoided whenever possible. The code recognizes that it is occasionally necessary to cut, notch or bore through studs, joists, beams, rafters or other structural members to install pipes, plumbing fixtures and appliances [see Figures 307.2(1) and 307.2(2)]. In order to maintain the integrity and load-carrying capacity of these structural members, the IBC is referenced to regulate the size and location of holes, notches, and other such modifications (see IBC Sections 2308.8.2 and 2308.9.10). If a structural member is to be modified beyond what is specifically permitted by the IBC, a structural analysis performed by a registered design professional and approved by the code official would be necessary to determine the effect that an alteration has had or will have on the load-carrying capacity of that structural member. Clearly, this should be considered before such alteration is made. Thoughtless cutting can result in an unnecessary hazard and expensive repair or replacement of improperly modified structural members.

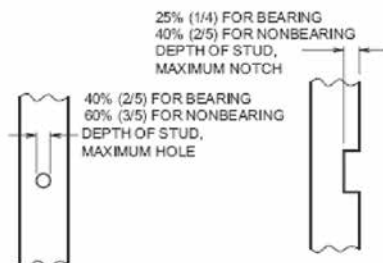
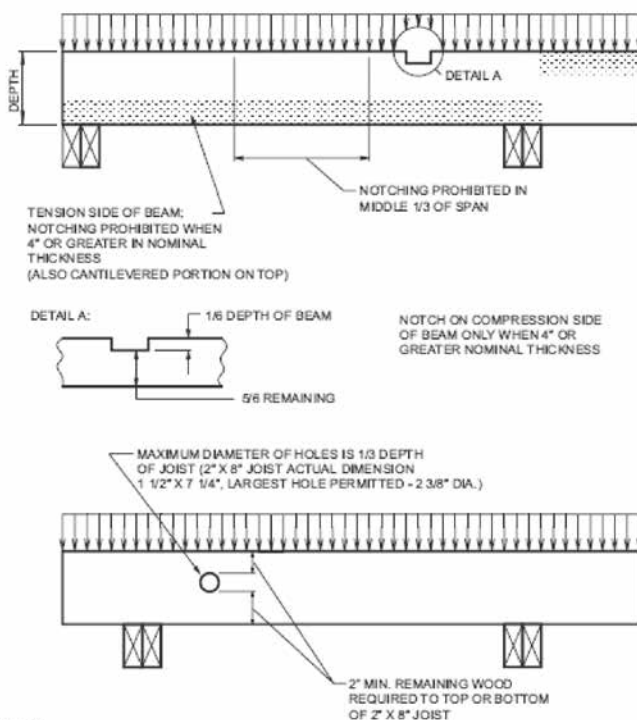

Figure 307.2(1)
NOTCHES OR HOLES IN WOOD STUDS



For SI: 1 inch = 25.4 mm.

Figure 307.2(2)
HOLES AND NOTCHES IN WOOD JOISTS

307.3 Penetrations of floor/ceiling assemblies and fire-resistance-rated assemblies. Penetrations of floor/ceiling assemblies and assemblies required to have a fire-resistance rating shall be protected in accordance with the *International Building Code*.

❖ This section provides the requirement for the protection of penetrations and openings necessary for plumbing pipe in building assemblies that are required to be fire-resistance rated. In addition to maintaining the structural integrity of walls, floors, ceilings and roofs when these elements are penetrated by the plumbing pipe, the penetrations must also be protected to prevent the passage of fire and other products of combustion through the fire-resistance-rated assembly because of the pipe penetrating the assembly. These penetrations must be protected in accordance with the IBC [see Sections 711 and 712 of the IBC and Figures 307.3(1) through 307.3(4)].

[B] 307.4 Alterations to trusses. Truss members and components shall not be cut, drilled, notched, spliced or otherwise altered in any way without written concurrence and approval of a registered design professional. Alterations resulting in the addition of loads to any member (e.g., HVAC equipment, water heater) shall not be permitted without verification that the truss is capable of supporting such additional loading.

❖ Trusses are engineered products, and any alteration to specific elements may prevent the truss from performing as intended. The code does not permit drilling and notching of truss members and components without documentation that the design has taken this possibility into account. Additionally, trusses are designed to resist specific loads; changing the loading on the truss or on any of its members should not be done without approval of a registered design professional.

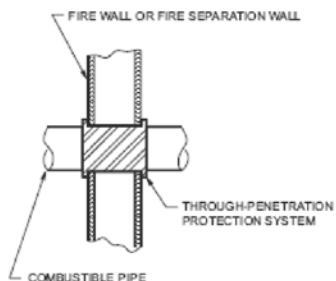

Figure 307.3(1)
COMBUSTIBLE PIPE PENETRATION OF FIRE WALL

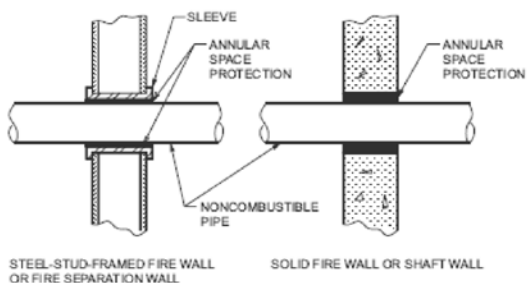

Figure 307.3(2)
ANNULAR SPACE PROTECTION

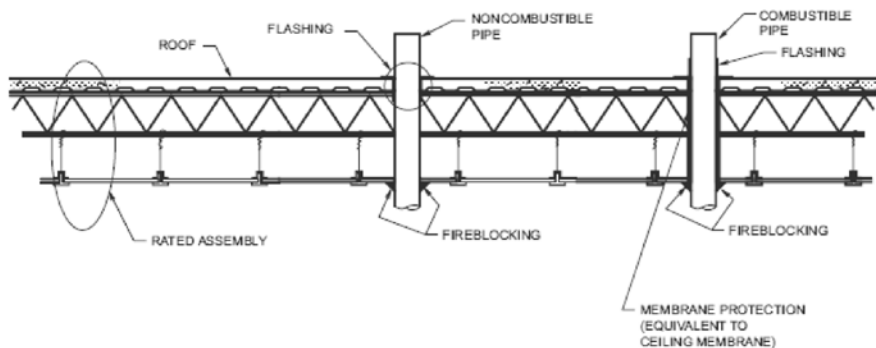

Figure 307.3(3)
PIPE PENETRATION OF FIRE-RESISTANCE-RATED ROOF/CEILING ASSEMBLY



HTX & SXHT Series Hydronic Expansion Tanks

QUICK SIZING GUIDE				
Boiler Output 1000's BTUH	Copper Baseboard & Radiant	Type of Radiation		
		Convectors & Unit Heaters	Cast Iron	
			Radiators	Baseboard
25	HTX 15	HTX 15	HTX 15	HTX 15
50	HTX 15	HTX 30	HTX 30	HTX 30
75	HTX 30	HTX 30	HTX 60	HTX 60
100	HTX 30	HTX 30	HTX 60	HTX 60
125	HTX 30	HTX 60	HTX 60	HTX 60
150	HTX 30	HTX 60	HTX 90	HTX 90
175	HTX 60	HTX 60	HTX 90	HTX 90
200	HTX 60	HTX 60	HTX 90	HTX 90
250	SXHT 30	SXHT 30	SXHT 40	SXHT 30
300	SXHT 30	SXHT 40	SXHT 40	SXHT 30
350	SXHT 30	SXHT 40	SXHT 60	SXHT 40
400	SXHT 30	SXHT 60	SXHT 90	SXHT 40
500	SXHT 40	SXHT 60	SXHT 90	SXHT 40
600	SXHT 40	SXHT 90	SXHT 90	SXHT 60
700	SXHT 60	SXHT 90	SXHT 90	SXHT 60
800	SXHT 60	SXHT 110	SXHT 110	SXHT 90
900	SXHT 60	SXHT 110	SXHT 110	SXHT 90
1000	SXHT 90	SXHT 110	SXHT 110	SXHT 90

Sizing recommendations based on average size systems.

Fill pressure 12 PSI. Relief valve 30 PSI.

Average system water temperature 200°F.

300 Pond Street, Randolph, Massachusetts 02368

Call 1.781.986.2424 • Fax 1.781.986.2029

www.flexconind.com



PLUMBING & HEATING DIVISION

HTX & SXHT Series Hydronic Expansion Tanks

COMPETITIVE CROSS-REFERENCE GUIDE

FLEXCON	VENT-RITE	AMTROL	WATTS	STATE	ELBI	WILKINS
HTX 15	VR15	15	ET-15	ET-20	XT-15	HXT-15
HTX 30	VR30	30	ET-30	ET-5	XT-30	HXT-30
HTX 60	VR60	60	ET-60	ET-7	XT-60	HXT-60
HTX 90	VR90	90	ET-90	ET-14	XT-90	HXT-90
SXHT 30	SXVR30	SX30	N/A	ET-15	XTV-30	N/A
SXHT 40	SXVR40	SX40	N/A	ET-20	XTV-40	N/A
SXHT 60	SXVR60	SX60	N/A	ET-36	XTV-60	N/A
SXHT 90	SXVR90	SX90	N/A	ET-52	XTV-90	N/A
SXHT 110	SXVR110	SX110	N/A	N/A	XTV-110	N/A
SXHT 160	SXVR160	SX160	N/A	ET-96	XTV-160	N/A

300 Pond Street, Randolph, Massachusetts 02368 • Call 1.781.986.2424 • Fax 1.781.986.2029

www.flexconind.com



PH, WH & WHV Series Potable Water Thermal Expansion Tanks

QUICK SIZING GUIDE				
Water Heater Size/ Volume	Maximum Water Temperature			
	130°F	140°F	160°F	180°F
30 gal	PH-5 or WH-8	PH-5 or WH-8	PH-5 or WH-8	PH-5 or WH-8
40 gal	PH-5 or WH-8	PH-5 or WH-8	PH-5 or WH-8	PH-5 or WH-8
50 gal	PH-5 or WH-8	PH-5 or WH-8	PH-5 or WH-8	PH-12 or WH-18
60 gal	PH-5 or WH-8	PH-5 or WH-8	PH-5 or WH-8	PH-12 or WH-18
80 gal	PH-5 or WH-8	PH-12 or WH-18	PH-12 or WH-18	PH-12 or WH-18
100 gal	PH-12 or WH-18	PH-12 or WH-18	PH-12 or WH-18	WH-32
120 gal	PH-12 or WH-18	PH-12 or WH-18	PH-12 or WH-18	WH-32
150 gal	PH-12 or WH-18	PH-12 or WH-18	WH-32	WH-32
175 gal	PH-12 or WH-18	WH-32	WH-32	WHV-50
200 gal	WH-32	WH-32	WHV-50	WHV-50
240 gal	WH-32	WH-32	WHV-50	WHV-75
260 gal	WH-32	WHV-50	WHV-50	WHV-75
280 gal	WH-32	WHV-50	WHV-75	WHV-75
300 gal	WHV-50	WHV-50	WHV-75	WHV-120
350 gal	WHV-50	WHV-50	WHV-75	WHV-120
400 gal	WHV-50	WHV-75	WHV-120	WHV-120

Based on total water heater recovery from 40°F.

Based on water supply pressure of 60 PSIG.

Relief valve set at 150 PSIG.

Adjust tank precharge to equal incoming water pressure.

300 Pond Street, Randolph, Massachusetts 02368

Call 1.781.986.2424 • Fax 1.781.986.2029

www.flexconind.com



PLUMBING & HEATING DIVISION

PH, WH & WHV Series Potable Water Thermal Expansion Tanks

COMPETITIVE CROSS-REFERENCE GUIDE

FLEXCON	AMTROL	WATTS	STATE	ELBI	B&G	WILKINS
PH-5 or WH-8	ST-5	PET or DET-5	ETC-2X	DXT-8	PT-15	WXTP-8 or XT-8
PH-12 or WH-18	ST-12	PET or DET-12	ETC-5X	DXT-18	PT-12	WXTP-18 or XT18
WH-32	ST-25V	PET or DET-25	ETC-7X	DXT-35	PT-25V	WXTP-32
WHV-50	ST-30V	PET or DET-30	ETC-14X	DXT-50	PT-30V	WXTP-50V
WHV-75	ST-42V	N/A	N/A	N/A	PT-42V	WXTP-75V
WHV-120	ST-60V	N/A	N/A	N/A	PT-60V	WXTP-120V
WHV-165	ST-80V	N/A	N/A	N/A	PT-80V	WXTP-165V
WHV-320	ST-210V	N/A	N/A	N/A	PT-210V	WXTP-320V

300 Pond Street, Randolph, Massachusetts 02368 • Call 1.781.986.2424 • Fax 1.781.986.2029

www.flexconind.com

CELSIUS TO FAHRENHEIT CONVERSION CHART

Celsius	Fahrenheit	Celsius	Fahrenheit	Celsius	Fahrenheit	Celsius	Fahrenheit
0.1	32.18	20	68	50	122	80	176
0.2	32.36	21	69.8	51	123.8	81	177.8
0.3	32.54	22	71.6	52	125.6	82	179.6
0.4	32.72	23	73.4	53	127.4	83	181.4
0.5	32.9	24	75.2	54	129.2	84	183.2
0.6	33.08	25	77	55	131	85	185
0.7	33.26	26	78.8	56	132.8	86	186.8
0.8	33.44	27	80.6	57	134.6	87	188.6
0.9	33.62	28	82.4	58	136.4	88	190.4
1	33.8	29	84.2	59	138.2	89	192.2
2	35.6	30	86	60	140	90	194
3	37.4	31	87.8	61	141.8	91	195.8
4	39.2	32	89.6	62	143.6	92	197.6
5	41	33	91.4	63	145.4	93	199.4
6	42.8	34	93.2	64	147.2	94	201.2
7	44.6	35	95	65	149	95	203
8	46.4	36	96.8	66	150.8	96	204.8
9	48.2	37	98.6	67	152.6	97	206.6
10	50	38	100.4	68	154.4	98	208.4
11	51.8	39	102.2	69	156.2	99	210.2
12	53.6	40	104	70	158	100	212
13	55.4	41	105.8	71	159.8	200	392
14	57.2	42	107.6	72	161.6	300	572
15	59	43	109.4	73	163.4	400	752
16	60.8	44	111.2	74	165.2	500	932
17	62.6	45	113	75	167	600	1112
18	64.4	46	114.8	76	168.8	700	1292
19	66.2	47	116.6	77	170.6	800	1472
		48	118.4	78	172.4	900	1652
		49	120.2	79	174.2	1000	1832

For greater accuracy use formula below:

To convert from Celsius to Fahrenheit:

$$°F = (9/5)°C + 32$$

To convert from Fahrenheit to Celsius:

$$°C = (5/9) \times (°F - 32)$$

°C = temperature in degrees Celsius

°F = temperature in degrees Fahrenheit

Maine Home Construction Contracts

The Maine Home Construction Contracts Act requires you use a written contract with specific provisions whenever the construction or repair contract is for more than \$3,000. For example, the contract must limit any down payment to no more than one third (1/3) of the total price and the contract must include an express warranty of good workmanship. **A sample contract can be found at www.maine.gov/ag at chapter 18.** **Another important feature of this statute is that you are now required to attach a copy of the AG's "consumer protection information on home construction and repair, which includes information on contractors successfully sued by the State" and the Statute also requires a clear and conspicuous notice on your contract strongly advising the consumer to visit the AG website at www.maine.gov/ag or telephone the AG at 1-800-436-2131.**

§ 1487. Home Construction Contracts Any home construction contract for more than \$3,000 in materials or labor must be in writing and must be signed by both the home construction contractor and the homeowner or lessee. Both the contractor and the homeowner or lessee shall receive a copy of the executed contract prior to any work performance. This basic contract must contain the entire agreement between the homeowner or lessee and the home construction contractor and must contain at least the following parts:

1. Names of parties. The name, address and phone number of both the home construction contractor and the homeowner or lessee;
2. Location. The location of the property upon which the construction work is to be done;
3. Work dates. Both the estimated date of commencement of work and the estimated date when the work will be substantially completed. The estimated date of commencement of work and the completion date may be changed if work cannot begin or end due to circumstances beyond the control of the contractor, including, but not limited to, the lack of readiness of the job site or the unavailability of building materials;
4. Contract price. The total contract price, including all costs to be incurred in the proper performance of the work, or, if the work is priced according to a "cost-plus" formula, the agreed-upon price and an estimate of the cost of labor and materials;
5. Payment. The method of payment, with the initial down payment being limited to no more than one-third of the total contract price;
6. Description of the work. A general description of the work and materials to be used;
7. Warranty. A warranty statement which reads: In addition to any additional warranties agreed to by the parties, the contractor warrants that the work will be free from faulty materials; constructed according to the standards of the building code applicable for this location; constructed in a skillful manner and fit for habitation or appropriate use. The warranty rights and remedies set forth in the Maine Uniform Commercial Code apply to this contract;
8. Resolution of disputes. A statement allowing the parties the option to adopt one of 3 methods of resolving contract disputes. At a minimum, this statement must provide the following information:

If a dispute arises concerning the provisions of this contract or the performance by the parties, then the parties agree to settle this dispute by jointly paying for one of the following (check only one):

Binding arbitration as regulated by the Maine Uniform Arbitration Act, with the parties agreeing to accept as final the arbitrator's decision (____);

1. Nonbinding arbitration, with the parties free to not accept the arbitrator's decision and to seek satisfaction through other means, including a lawsuit (____);
2. Mediation, with the parties agreeing to enter into good faith negotiations through a neutral mediator in order to attempt to resolve their differences (____);
9. Change orders. A change order statement which reads: Any alteration or deviation from the above contractual specifications that result in a revision of the contract price will be executed only upon the parties entering into a written change order;
10. Door-to-door sales. If the contract is being used for sales regulated by the consumer solicitation sales law, Title 32, chapter 69, subchapter V or the home solicitation sales law, Title 9-A, Part 5, a description of the consumer's rights to avoid the contract, as set forth in these laws;
11. Residential insulation. If the construction includes installation of insulation in an existing residence, any disclosures required by chapter 219, Insulation Contractors; and
12. Energy standards. A statement by the contractor that chapter 214 establishes minimum energy efficient building standards for new residential construction, and whether the new building or an addition to an existing building will meet or exceed those standards.

§ 1488. Change Orders Each change order to a home construction contract must be in writing and becomes a part of and is in conformance with the existing contract. All work shall be performed under the same terms and conditions as specified in the original contract unless otherwise stipulated. The change order must detail all changes to the original contract that result in a revision of the contract price. The previous contract price must be stated and the revised price shall also be stated. Both parties must sign the change order.

§ 1489. Exemption Parties to a home construction contract may exempt themselves from the requirements of this chapter only if the contractor specifically informs the homeowner or lessee of his rights under this chapter and the parties then mutually agree to a contract or change order that does not contain the parts set forth in sections 1487 and 1488

PLUMBING PRODUCTS LINE CARD



AQUARIUS
BATHWARE™

Complete line of solid surface, acrylic and Acrylx bathtubs and showers. Featuring special needs, commercial & residential units.



Renovative
Bath Systems

Classically styled multi-piece showers and pans designed for accessible renovation.



Code compliant healthcare bath fixtures and innovative trench drain systems with finishes in solid surface, acrylic and Acrylx.



Flush valves and faucets in both sensor and solar. Water Sense certified. Available in different finishes.



AQUADESIGN
MANUFACTURING

Hand wash systems featuring stainless steel and solid surface. Behavioral healthcare (ligature resistant) product.



Master gas controllers for science labs. MA approved CO kitchen interlock system. Outdoor fire pit and gas grill controls. (Excluding Western MA & CT.)



Stainless steel handsinks, scullery sinks, classroom sinks, and mop sinks.



ProVent single stack system. Whisper quiet pipe, ProSet firestop penetrators.



Decorative drinking fountains and bottle filling stations in a variety of finishes. Chillers and purification systems



Grease, oil, lint, sand, and sediment separators. Parking garage catch basins.



Stainless Steel drainage products. Trench and floor drains, cleanouts, and floor sinks. NSF certified.



Pipe supports for flat roofs, roof hydrants, and pedestal disconnects. (Excluding Western MA & CT.)



Toilet and shower partitions in all materials.



Grab bars and shower seats in a variety of finishes.



Glass acid waste and vent systems.



Collapsible water dams, weighted and caregiver shower curtains for barrier-free showers.



"The Clam" stainless steel closet replacement flange.



Stainless steel fixtures for prisons, jails, detention centers, parks/recreation, healthcare, and hospitality.



Cast iron single stack soil and waste system.

Directory of
Local Plumbing Inspectors/CEO

ABBOT

Brian Turner

Office: (207) 876-3340

Home: (207) 997-3287

Cell: (207) 717-0053

ACTON

James Sevigny

35 H Rd

Acton, ME 04001

Office: (207) 636-3131 ext 409

ceo@actonmaine.org

ADDISON

Judy Rolfe

PO Box 142

Addison, ME 04606

Office: (207) 546-6031

ALBION

Crystal Nichols

(207) 505-0743

ceo@townofalbionmaine.org

ALEXANDER

James Slowe

Phone: (207) 788-3877

ALFRED

James Allaire

Phone: (207) 324-5872 ext 206

jallaire@alfredme.gov

Michael Gilpatrick

PO Box 667

Alfred, ME 04002

Office: (207) 324-5872

ALLAGASH

Dennis Cyr

100 St John Rd

Fort Kent, ME 04743

Office: (207) 834-3136

Home: (207) 834-3862

ALNA

Bruce Engert

1568 Alna Rd

Nobleboro, ME 04535

Office: (207) 586-5313

ceo.lpi.alna@gmail.com

ALTON

Philip Stevens, Jr.

(774) 276-0854

AMHERST

Rebecca Albright

382 Point Rd

Otis, ME 04605

Office: (207) 584-5860

Home: (207) 537-3263

dreaminadrum@yahoo.com

AMITY

Clarissa Porter

Phone: (207) 538-5467

ANDOVER

Randy Thurston

17 Stillman Rd

Andover, ME 04216

Office: (207) 392-3302

ceo.andover@gmail.com

ANSON

Leo Mayo

PO Box 297

Anson, ME 04911

Office: (207) 696-3979

lem4749@gmail.com

APPLETON

C. Toupie Rooney

60 Flanders Rd

Northport, ME

Phone: (207) 338-3819

ARROWSIC

Chris Wilcoxson

58 Iron Mine Rd

Arrowsic, ME 04530

Phone: (207) 650-2920

chris.wilcoxson@arrowsic.org

ARUNDEL

James Nagle

PO Box 263

Long Island, ME 04050

Office: (207) 985-4201 ext 107

ceo@arundelmaine.org

ASHLAND

Margaret Pierce

17 Bridgham St

Ashland, ME 04731

Office: (207) 554-0289

mpierce17@aol.com

ATHENS

Kenneth A Hogate

Phone: (207) 674-3471

AUBURN

Mark Stambach

60 Court St, Ste 104

Auburn, ME 04210

Office: (207) 333-6601 ext 1160

mstambach@auburnmaine.gov

AUGUSTA

Keegan Ballard

16 Cony St City Center

Augusta, ME 04330

Office: (207) 626-2365

keegen.ballard@augustamaine.gov

Robert Overton

Office: (207) 626-2365

robert.overton@augustamaine.gov

AVON

Stephen Ochmanski

1116 Rangeley Rd

PO Box 330

Phillips, ME 04966

Office: (207) 639-5326

Home: (207) 268-4721

BAILEYVILLE

Jamie Bohanon

63 Broadway

Baileyville, ME 04694

Phone: (207) 427-3442

codeenforcementplanning@

baileyville.org

BALDWIN

Donald Kent

534 Pequawket Trail

West Baldwin, ME 04091

Phone: (207) 625-3581 ext 3

baldwinmaineceo@gmail.com

BANGOR

Jeff Wallace

City Hall 73 Harlow St
Bangor, ME 04401
Phone: (207) 992-4228
code.enf@bangormaine.gov

BAR HARBOR

Millard Billings

93 Cottage St
Bar Harbor, ME 04609
Office: (207) 288-3329
Cell: (207) 244-7204
mbillings46@yahoo.com

BATH

Scott Davis

55 Front St
Bath, ME 04530
Office: (207) 443-8334
sdavis@cityofbath.com

BEAVER COVE

Brian Turner

Phone: (207) 997-3287

BELFAST

Steve Wilson

131 Church St
Belfast, ME 04915
Phone: (207) 338-3370 ext 133
ceo@cityofbelfast.org

BELGRADE

Hans Rasmussen

16 Cony St City Center
Augusta, ME 04330
Office: (207) 495-2258
Cell: (207) 485-4615
ceo@townofbelgrade.com

BELMONT

Cindy Abbott

613 Back Belmont Rd
Belmont, ME 04952
Office: (207) 342-5722
ceo@belmontme.org

BERWICK

Irish Griffith

11 Sullivan St
Berwick, ME 03901
Phone: (207) 698-1101 ext 122
code@berwickmaine.org

BETHEL

Courtney Mcpherson

19 Main St
PO Box 1660
Bethel, ME 04217
Phone: (207) 824-2669
ceo@bethelmaine.org

BIDDEFORD

Roby Fecteau

205 Main St
Biddeford, ME 04005
Office: (207) 284-9236
roby.fecteau@biddefordmaine.org

BINGHAM

Timothy Andrews

PO Box 652
Bingham, ME 04920
Phone: (207) 592-5638

BLUE HILL

Bryce Farnham

Office: (207) 374-5192

BOOTHBAY

Daniel Feeney

PO Box 106
Boothbay, ME 04537
Office: (207) 633-2051 ext 15
jlorrain@townofboothbay.org

BOOTHBAY HARBOR

Geoff Smith

11 Howard St
Boothbay Harbor, ME 04538
Office: (207) 633-3671
gsmith@boothbayharbor.org

BOWDOIN

Dennis Douglass

23 Cornish Dr
Bowdoin, ME 04287
Phone: (207) 250-2399
Cell: (207) 751-6778
dennis@bowdoinmaine.gov

BOWDOINHAM

Matthew James

13 School St
Bowdoinham, ME 04008
Office: (207) 666-5531
ceo@bowdoinham.com

BOWERBANK

Brian Turner

PO Box 41
Monson, ME 04464
Home: (207) 997-3287
copalt@myfairpoint.net

Keith Doore

PO Box 457
Dover Foxcroft, ME 04426
Phone: (207) 343-1669
townofbowerbank@gmail.com

BRADFORD

Luke Ahmed

345 East Rd
PO Box 26
Bradford, ME 04410
Phone: (207) 327-2121
manager@bradfordmaine.org

BRADLEY

Dean Bennett-CEO

dbennett@townofbradley.net

Phil Stevens-LPI

Phone: (774) 276-0854
outdoors017@yahoo.com

BREMEN

Stanley Waltz

133 Eugley Hill Rd
Nobleboro, ME 04555
Office: (207) 832-7351
Cell: (207) 380-9873
nobleborocoo@gmail.com

BREWER

Kristie Rines

30 North Main St
Brewer, ME 04412
Office: (207) 989-7790
krines@brewermaine.gov

Richard Houpp

30 North Main St
Brewer, ME 04412
Office: (207) 989-7790
rhoup@brewermaine.gov

BRIDGTON

Brenda Day

Office: (207) 647-8786
Cell: (207) 803-9963
bday@bridgtonmaine.org

BRISTOL

Joseph R Rose
1268 Bristol Rd
Bristol, ME 04539
Office: (207) 563-5270 ext 303
Cell: (207) 380-9873
bristolceo@tidewater.net

BROOKLIN

Judy Jenkins
Phone: (207) 266-0785

BROOKS

Randy Hall
15 Purple Heart
Brooks, ME 04921
Office: (207) 722-3254
Cell: (207) 234-4006
randy_006@msn.com

BROOKSVILLE

Joseph Devlin
Phone: (207) 326-8567
John Gray
Phone: (207) 326-4578

BROWNFIELD

Michael Vane
Phone: (207) 935-2007 ext 202
Cell: (207) 205-1169
townceo@fairpoint.net

BROWNVILLE

Daniel Gilbert
586 Main Rd
Brownville, ME 04414
Office: (207) 965-2561
Home: (207) 938-3866
moosedan@tdstelme.net

BRUNSWICK

Mike Pindell
Town Ofc / 28 Federal St
Brunswick, ME 04011-1583
Office: (207) 725-6660 ext 4024
mpindell@brunswickme.org

BUCKFIELD

Kingston Brown
34 Turner St
PO Box 179
Buckfield, ME 04220
Phone: (207) 595-4555
ceo@townofbuckfield.org

BUCKSPORT

Luke Chiavelli
50 Main St
PO Box X
Bucksport, ME 04414
Office: (207) 469-7368
ceo@bucksportmaine.gov

BURNHAM

Randy Hall
37 South Rd
Dixmont, ME 04932
Office: (207) 991-0117
Cell: (207) 234-4006
randy_006@msn.com

BUXTON

Patti McKenna
185 Portland Rd
Buxton, ME 04093
Phone: (207) 929-3046
ceobuxton@saconver.net

CALAIS

Andrea Walton
PO Box 413
Calais, ME 04619
Phone: (207) 454-2521 ext 1006
assessor@calaismaine.org

CAMBRIDGE

Brian Turner
202 Ripley Rd
Cambridge, ME 04923
Phone: (207) 277-3241
Cell: (207) 997-3287
copalt@myfairpoint.net

CAMDEN

Clint Beveridge
29 Elm St
PO Box 1207
Camden, ME 04843
Office: (207) 236-3353 ext 7114
codes@camdenmaine.gov

CANAAN

Randy Gray
277 Main St
PO Box 68
Canaan, ME 04924
Phone: (207) 474-6883

CAPE ELIZABETH

Benjamin Mcdougal
320 Ocean House Rd
Cape Elizabeth, ME 04116
Office: (207) 799-1619
benjamin.mcdougal@
capeelizabeth.org

CARIBOU

Tony Michaud
25 High St
Caribou, ME 04736
Office: (207) 493-3324
tmichaud@cariboumaine.org

CARMEL

Kevin Howell
PO Box 114
Carmel, ME 04419
Office: (207) 848-3361
ceo@townofcarmel.org

CARRABASSET VALLEY

Christopher Parks
cvceo@roadrunner.com

CASCO

John Wiesemann
635 Meadow Rd
Casco, ME 04015
Office: (207) 627-1346
ceoadmin@cascomaine.org

CASTINE

Peter Vogell
PO Box 17
Castine, ME 04221
Office: (207) 326-4502
Home: (207) 326-9334

Dale Abernethy

PO Box 204
Castine, ME 04421
Office: (207) 326-4502

CENTERVILLE

Charles S. Peterson
1 East Main St
RR1 Box 12
Harrington, ME 04643
Office: (207) 483-2398
Home: (207) 483-2398

LOCAL PLUMBING INSPECTORS

CHEBEAGUE ISLAND

Tammy Munson

192 North Rd
Chebeague Island, ME 04017
Falmouth, ME 04105
Office: (207) 846-3148
codeoffice@
townofchebeagueisland.org

CHELSEA

Greg Lumbert

560 Togus Rd
Chelsea, ME 04330
Office: (207) 582-4802
chelseaceo@chelseamaine.org

CHESTER

Jerry Davis

184 Transalpine Rd
Lincoln, ME 04457
Office: (207) 794-3372
Home: (207) 794-3202
codeofficer@lincolmaine.org

CHESTERVILLE

John Arnold

409 Dutch Gap
Chesterville, ME 04938
Phone: (207) 242-3331
chestervillecodes@gmail.com

CHINA

Jaime Hanson

571 Lakeview Dr
China, ME 04358
Office: (207) 445-2014
Cell: (207) 660-5865
ceo@chinamaine.org

CLIFTON

Richard Leavitt

135 Airline Rd
Clifton, ME 04428
Home: (207) 843-0709
Cell: (207) 949-6775

CLINTON

Garrett Lower

27 Baker St
Clinton, ME 04927
Office: (207) 426-8320
glower@clinton-me.gov

COOPER

Dan Ackley

Phone: (207) 214-6996
danackley58@gmail.com

CORINNA

Albert Tempesta

8 Levi Stewart Dr
Corinna, ME 04928
Office: (207) 278-4183
corinnaceo@roadrunner.com

CORINTH

Adam Caldwell

PO Box 309
Corinth, ME 04427
Phone: (207) 285-3271
ceo@townofcorinth.com

CORNISH

Dan Vaillancourt

17 Maple St
Cornish, ME 04020
Phone: (207) 653-4608
ceo@cornishme.com

CRANBERRY ISLE

Dennis Dever

PO Box 248
Northeast Harbor, ME 04662
Phone: (207) 664-3680
dysonsys@twc.com

CUMBERLAND

William C Longley

200 Main St
Yarmouth, ME 04096
Office: (207) 829-2207

CUSHING

Matthew Deane

Office: (207) 354-2375
codecushingme@roadrunner.com

CUTLER

Kevin Brodie

2655 Cutler Rd
PO Box 236
Cutler, ME 04626
Phone: (207) 263-4243

DAMARISCOTTA

George Chase

21 School St
Damariscotta, ME 04543
Office: (207) 563-5168

DANFORTH

James Slowe

Phone: (207) 448-2321

DAYTON

James Roberts

249 Hight Rd
Dayton, ME 04005
Office: (207) 499-3034
ceo@dayton-me.gov

DEDHAM

Richard Leavitt

22 Thompson Rd
Dedham, ME 04429
Home: (207) 843-6217
Cell: (207) 949-6775
rik43@aol.com

DEER ISLE

Robert Brown

70 Church St
PO Box 46
Deer Isle, ME 04627
Office: (207) 348-6060
Cell: (207) 479-1405

Judy Jenkins

70 Church St
PO Box 46
Deer Isle, ME 04627
Office: (207) 348-6060
Cell: (207) 266-0785
judybluehill@yahoo.com

DENMARK

Lyndsay Snow

62 East Main St
Denmark, ME 04022
Office: (207) 452-2207
ceo@denmarkmaine.org

DEXTER

Albert Tempesta

Twn Ofc / 23 Water St
Newport, ME 04953
Phone: (207) 924-7620
townceo@dextermaine.org

DIXFIELD

Ryan Glover

46 Main St
PO Box 808
Dixfield, ME 04224
Office: (207) 562-8151
Cell: (207) 418-5026

DIXMONT

Randy Hall

37 South Rd
Dixmont, ME 04932
Office: (207) 991-0117
Cell: (207) 234-4006
randy_006@msn.com

DOVER-FOXCROFT

Brian Gaudet

48 Morton Ave, Ste A
Dover-Foxcroft, ME 04426
Office: (207) 564-3318 ext 1025
bgaudet@dover-foxcroft.org

DRESDEN

James Valley

534 Gardiner Rd
PO Box 30
Dresden, ME 04342
Phone: (207) 737-4305
townofdresden.com

EAST MACHIAS

James Bradley

PO Box 521
E. Machias, ME 04630
Office: (207) 255-8874
Home: (207) 255-8874

EAST MILLINOCKET

Jason Pelkey

53 Main St
E Millinocket, ME 04430
Phone: (207) 746-3551
ceo@eastmillinocket.org

EASTBROOK

959 Eastbrook Rd
Eastbrook, ME 04634
Phone: (207) 460-1044

EASTON

Tony Levesque

18 Community Center Dr
Fort Fairfield, ME 04742
Office: (207) 472-3805

EASTPORT

Polly Sullivan

22 Washington St
Eastport, ME 04631
Office: (207) 853-2300

EDDINGTON

Rick Leavitt

906 Main Rd
Eddington, ME 04428
Phone: (207) 949-6775
rik43@aol.com

EDGECOMB

Jarrold Pinkham

PO Box 139
Edgecomb, ME 04556
Phone: (207) 380-7042

ELIOT

Shelly Bishop

1333 State Rd
Eliot, ME 03903
Office: (207) 439-1813 ext 110

ELLSWORTH

Lori Roberts

1 City Hall Plaza
Ellsworth, ME 04605
Office: (207) 667-4910
lroberts@ellsworthmaine.gov

EMBDEN

Terriann Lamontagne

809 Emden Pond Rd
Embden, ME 04958
Office: (207) 566-5551 ext 4
emden-ceo@embden.org

ENFIELD

789 Hammett Rd
Enfield, ME 04493
Phone: (207) 732-4270
townofenfield.com

ETNA

Randy Hall

37 South Rd
Dixmont, ME 04932
Office: (207) 234-4006
Home: (207) 234-4006
randy_006@msn.com

EUSTIS

Peter Farnsworth

88 Main St
PO Box 350
Stratton, ME 046982
Phone: (207) 246-4401

EXETER

Phil Stevens

Phone: (774) 276-0854
outdoors017@yahoo.com

FAIRFIELD

Nicole Martin

19 Lawrence Ave
PO Box 149
Fairfield, ME 04937
Office: (207) 453-7765
Cell: (207) 861-2400
nmartin@fairfieldme.com

FALMOUTH

Justin Brown

271 Falmouth Rd
Falmouth, ME 04105
Office: (207) 699-5306
jbrown@town.falmouth.me.us

Craig Jones

271 Falmouth Rd
Falmouth, ME 04105
Phone: (207) 699-5334
cjones@town.falmouth.me.us

FARMINGDALE

Greg Lambert

289 Maine Ave
Farmingdale, ME 04344
Phone: (207) 592-7073
farmingdalemelpi@gmail.com

FARMINGTON

Stevens Kaiser

870 Holley Rd
Farmington, ME 04938
Phone: (207) 778-5874
ceo@farmington-maine.org

FAYETTE

Jessica Leighton

2589 Main St
Fayette, ME 04349
Phone: (207) 685-4373
fayetteceo@gmail.com

FORT FAIRFIELD

Richard Levesque Jr

18 Community Center Dr
Fort Fairfield, ME 04742
Office: (207) 472-3805

LOCAL PLUMBING INSPECTORS

FORT KENT

Cole Pelletier

416 West Main St
Fort Kent, ME 04743
Office: (207) 834-3507
cole.pelletier@fortkent.org

FRANKFORT

Randy Hall

37 South Rd
Dixmont, ME 04932
Office: (207) 991-0117
randy_006@msn.com

C Timothy Schoppe

455 Clark Rd
Hermon, ME 04401
Office: (207) 848-3043
Home: (207) 848-2679

FRANKLIN

Millard Billings

34 Main St
Franklin, ME 04634
Home: (207) 565-3663
franklinceo.lpi@gmail.com

FREEDOM

Jackie Robbins

71 Pleasant St
Freedom, ME 04941
Phone: (207) 525-7706

FREEPORT

Nick Adams

30 Main St
Freeport, ME 04032
Office: (207) 865-4743 ext 102

FRIENDSHIP

David Studer

PO Box 218
Friendship, ME 04438
Office: (207) 832-8224
ceofriendship@roadrunner.com

FRYE ISLAND

John Thompson

1 Sunset Rd
Frye Island, ME 04071
Cell: (207) 693-2150
codeenforcement@fryeisland

FRYEBURG

Caleb Bowles

16 Lovewell Pond Rd
Fryeburg, ME 04037
Office: (207) 935-2805

GARDINER

Kris McNeill

6 Church St
Gardiner, ME 04345
Office: (207) 620-4853
ceo@gardinermaine.com

GARLAND

PO Box 36
108 Corinth Rd
Corinth, ME 04939
Phone: (207) 924-3163

GEORGETOWN

Chris Wilcoxson

Phone: (207) 650-2920

GLENBURN

Michael Falvey

Office: (207) 942-2905
Phone: (207) 659-7026
ceo@glenburn.net

GORHAM

Freeman Abbott

75 South St, Ste 1
Gorham, ME 4038
Office: (207-222-1605
fabbott@gorham.me.us

GRAY

Tammy Munson

24 Main St
Gray, ME 04039
Phone: (207) 657-3112

GREENBUSH

Jerry Davis

PO Box 230
Greenbush, ME 04418
Phone: (207) 826-2050
greenbh@midmaine.org

GREENE

Kenneth Pratt

220 Main St
Greene, ME 04236
Office: (207) 946-5146
Cell: (207) 576-1413

GREENVILLE

Brian Turner

PO Box 41
Monson, ME 04464
Office: (207) 997-3641
Cell: (207) 997-3287

GREENWOOD

Joelle Corey-Whitman

593 Gore Rd
Greenwood, ME 04255
Office: (207) 875-2773
Phone: (207) 393-7705
ceojoele@hotmail.com

GUILFORD

Keith Doore

PO Box 355
Guilford, ME 04443
Office: (207) 876-2202

HALLOWELL

Gary Lamb

1 Winthrop St
Hallowell, ME 04347
Office: (207) 623-4021 ext 205
citymanager@hallowellmaine.org

HAMPDEN

Myles Block

106 Western Ave
Hampden, ME 04444
Office: (207) 862-4000 ext 8
code@hampdenmaine.gov

HANCOCK

Don Baker

18 Pt Rd
PO Box 68
Hancock, ME 04640
Office: (207) 422-3393
hancockceo@hancoctownoffice.com

HANOVER

Richard Coulombe

Phone: (207) 364-8200

HARMONY

Troy Gump

1 Main St
Harmony, ME 04942
Phone: (412) 443-5482
Office: (207) 683-5681
tgump@klhengineers.com

HARPSWELL

Tim Clark

PO Box 39
Harpowell, ME 04079
Office: (207) 833-5771
tclark@town.harpowell.me.us

HARRISON

John Wentworth

PO Box 300
Harrison, ME 04040
Office: (207) 583-0923

HARTLAND

Kim Norak

Twn Ofc / PO Box 280
Hartland, ME 04943
Phone: (207) 938-4401
hartlandcode@gmail.com

HARTFORD

Scott Mills

Phone: (207) 415-4381
scott@runawayridge.com

HEBRON

Kingston Brown

PO Box 304
Hebron, ME 04238
Phone: (207) 595-4555
kingston.brown@gmail.com

HERMON

Jessefa Murphy

333 Billings Rd
Hermon, ME 04401
Phone: (207) 848-1042
murphyj@hermonmaine.gov

HERSEY

Barry Higgins

1121 Dyer Brook Rd
Dyer Brook, ME 04747
Home: (207) 757-8556

HIRAM

Guy Lehouillier

16 Nasons Way
Hiram, ME 04041
Office: (207) 625-4463
Cell: (207) 256-2410
hiramceo@townofhiram.org

HOLDEN

Benjamin Breadmore

570 Main Rd
Holden, ME 04429
Office: (207) 843-5151
ceo@holdenmaine.org

HOLLIS

Duane Hanson

34 Town Farm Rd
Hollis, ME 04042
Office: (207) 929-2251
ceo@hollismaine.org

HOPE

Matthew Deane

441 Camden Rd
Hope, ME 04847
Office: (207) 763-4199
ceo-lpi@hopemaine.org

HOULTON

Benjamin Torres

21 Water St
Houlton, ME 04730
Office: (207) 532-7111
codeenforcement@houlton-
maine.com

HOWLAND

Dwight Tilton

PO Box 386
Howland, ME 04448
Phone: (207) 732-4112

HUDSON

Adam Caldwell

2150 Hudson Rd
Hudson, ME 04449
Phone: (207) 327-1284
codeenforcement@
townofhudson.me

ISLESBORO

David Dyer

Twn Ofc / Box 76
Islesboro, ME 04848
Office: (207) 734-2253

JACKMAN

Jason Bennett

369 Main St
Jackman, ME 04945
Phone: (207) 668-2111
Cell: (207) 399-8179
code.enforcement@jackmanme.net

JACKSON

Cindy Abbott

Phone: (207) 505-0743
cindyabbottceo@yahoo.com

JAY

Ronda Palmer

340 Main St
Jay, ME 04239
Phone: (207) 897-6785
jceo@jay-maine.org

JEFFERSON

Donald Waltz

PO Box 77
Jefferson, ME 04348
Office: (207) 549-7401
ceo@jeffersonmaine.org

JONESPORT

Elizabeth Fitzgerald

70 Snare Creek Lane
Jonesport, ME 04649
Phone: (207) 497-5926
Cell: (207) 255-3127

KENNEBUNK

Brian Paul

1 Summer St
Kennebunk, ME 04043
Office: (207) 985-2102 ext 1303

Frank Kunkel

Office: (207) 985-2102 ext 1303

KENNEBUNKPORT

David Gilchrest

6 Elm St
Kennebunkport, ME 04046
Office: (207) 967-1602

KINGFIELD

Thomas Marcotte

Phone: (207) 684-4111
(207) 265-4637
codeofficer@kingfieldmaine.org

KITTERY

Craig Alfis

Twn Ofc / PO Box 808
Kittery, ME 03904
Office: (207) 475-1308

KNOX

David Schofield

10 Abbott Rd
Knox, ME 04986
Cell: (207) 322-7365
mschofield@uninets.net

LOCAL PLUMBING INSPECTORS

LAGRANGE

Dwight Tilton
Rfd 1 Box 680
Lincoln, ME 04457
Home: (207) 732-3164

LAKEVILLE

Dwight Tilton
Phone: (207) 794-4434

LAMOINE

Rebecca Albright
606 Douglas Hwy
Lamoine, ME 04605
Office: (207) 667-2242

LEBANON

Dave Salvatore
15 Upper Guinea Rd
Lebanon, ME 04027
Office: (207) 457-6082

LEEDS

Larry Grant
8 Community Dr
PO Box 206
Leeds, ME 04263
Phone: (207) 524-2754
Cell: (207) 524-3491
leedsceo.19@gmail.com

LEVANT

Scott Pullen
PO Box 220
691 Town House Rd
Levant, ME 04456
townoflevant@roadrunner.com
Phone: (207) 884-7660

LEWISTON

Steve LeBrun
27 Pine St
Lewiston, ME 04240
Phone: (207) 513-3000 ext 3226
slebrun@lewistonmaine.gov

Richard Nicholas

27 Pine St
Lewiston, ME 04240
Phone: (207) 513-3000 ext 3231
richard@lewistonmaine.gov

LIMERICK

Stanley Hackett
55 Washington St
Limerick, ME 04048
Office: (207) 793-2166 ext 5

LIMESTONE

Brandon Saucier
322 Main St
Limestone, ME 04750
Office: (207) 325-4704 ext 104
code@limestonemaine.org

LIMINGTON

Craig Galarneau
425 Sokokis Ave
Limington, ME 04049
Office: (207) 637-5209
ceo@limingtonmaine.gov

LINCOLN

Wade Jordan
29 Main St
Lincoln, ME 04457
Office: (207) 794-3372
Cell: (207) 403-3306
wade.jordan@lincolnmaine.org

LINCOLNVILLE

Frank Therio
493 Hope Rd
Lincolnvillle, ME 04849
Office: (207) 763-3601
info@town.lincolnvillle.me.us

LISBON

Mark Stambach
Twn Ofc / 300 Lisbon St
Lisbon, ME 04250
Office: (207) 353-3000 ext 111
mstambach@lisbonme.org

LITCHFIELD

Stephen Ochmanski
16 Pleasant St
Phillips, ME 04966
Home: (207) 268-4721

LIVERMORE

Terry Pinkham
10 Crash Rd
Livermore, ME 04253
Phone: (207) 897-3207
livermorecodeofficer@gmail.com

LIVERMORE FALLS

Terry Pinkham
Phone: (207) 897-3207

LONG ISLAND

James Nagle
PO Box 263
Long Island, ME 04050
Office: (207) 985-4201
Phone: (207) 284-6857
ceo@townoflongisland.us

LOVELL

Alan Broyer
1069 Main St
Lovell, ME 04051
Office: (207) 925-6272
ceo@lovelmaine.org

LUBEC

Kevin Brodie
40 School St
Lubec, ME 04652
Office: (207) 733-2341
Cell: (207) 263-4243
lubecceo@gmail.com

LYMAN

Brenda Charland
24 Townhouse Rd
E. Waterboro, ME 04030
Office: (207) 247-0647
ceo@lyman-me.gov

Thomas Markley

14 Autumn Way
Falmouth, ME 04105
Office: (207) 874-8705
Home: (207) 797-9878

MACHIAS

Kevin Brodie
Phone: (207) 263-4243
whiting.chief290@gmail.com

MACHIASPORT

Betsy Fitzgerald
PO Box 267
Machiasport, ME 04655
Office: (207) 255-4516
Cell: (207) 263-5439

MADAWASKA

Denise Duperre
328 Saint Thomas St Ste 101
Madawaska, ME 04756
Office: (207) 728-3612
dduperre@madawaska.me

MADISON

26 Weston Ave
PO Box 190
Madison, ME 04950
Phone: (207) 696-3971
code@madisonmaine.com

MANCHESTER

Richard Greenwald
12 Readfield Rd
PO Box 18
Manchester, ME 04351
Office: (207) 622-1894
ceo@manchesterme.org

MARIAVILLE

Stephen Salsbury
Phone: (207) 537-2107
Cell: (207) 266-0106
code04605@gmail.com

MARS HILL

Bruce Hussey
PO Box 449
Mars Hill, ME 04758
Phone: (207) 554-9051

MARSHFIELD

James Bradley
PO Box 521
E. Machias, ME 04630
Office: (207) 255-8874
Home: (207) 255-8874

MECHANIC FALLS

Ryan Smith
108 Lewiston St
Mechanic Falls, ME 04256
Phone: (207) 345-2221
rsmith@mechanicfalls.org

MEDWAY

Dwight Tilton
4 School St
Medway, ME 04460
Phone: (207) 746-0531

MEXICO

Matt Theriault
PO Box 251
Mexico, ME 04257
Office: (207) 364-7971
Cell: (207) 507-99411

MILFORD

Michael Falvey
62 Davenport St
Milford, ME 04461
Phone: (207) 827-2072
ceo@milfordmaine.org

MILLINOCKET

197 Penobscot Ave
Millinocket, ME 04462
Phone: (207) 723-7005
code@millinocket.org

MILO

Steven Quist
6 Pleasant St
Milo, ME 04463
Phone: (774) 535-1041
ceo@townofmilo.org

MINOT

Scott McElravy
329 Woodman Hill Rd
Minot, ME 04258
Office: (207) 345-3305 ext 105
Cell: (207) 754-6881
codeofficer@minotme.org

MONMOUTH

Ernie Sylvester
859 Main St
Monmouth, ME 04259
Phone: (207) 481-9400
monmouthceo@monmouthme.org

MONROE

Cindy Abbott
Cell: (207) 505-0743

MONSON

Kent Rich
PO Box 308
Monson, ME 04464
Office: (207) 997-3641

MONTVILLE

Cindy Abbott
Cell: (207) 505-0743

MORRILL

Jeff Luce
44 Weymouth Rd
PO Box 59
Morrill, ME 04952
Phone: (207) 323-4370

MOSCOW

Kenneth Hogate
161 West Ridge Rd
Cornville, ME 04976
Office: (207) 474-8865

MOUNT DESERT

Kimberly Keene
21 Sea St
PO Box 248
Northeast Harbor, ME 04662
Office: (207) 276-5531
Phone: (207) 288-4024
ceo@mtdesert.org

MOUNT VERNON

Bill Butler
Phone: (207) 446-6541
ceo@mtvernonme.org

NAPLES

Kate Matthews
15 Village Green Ln
PO Box 1757
Naples, ME 04055
Office: (207) 693-6364 ext 107
kmatthews@townofnaples.org

NEW GLOUCESTER

Rick Haas
385 Intervale Rd
New Gloucester, ME 04260-0082
Office: (207) 926-4126 ext 3
codeofficer@newgloucester.com

NEW SHARON

Jon Arnold
11 School Ln
PO Box 7
New Sharon, ME 04955
Phone: (207) 242-3331
newsharon.codeenforcement@
gmail.com

NEW VINEYARD

Terrienne Lamontagne
20 Lake St
New Vineyard, ME 04956
Phone: (207) 652-2222
townofnewvineyard@gmail.com

LOCAL PLUMBING INSPECTORS

NEWCASTLE

George Chase
4 Pump St
PO Box 386
Newcastle, ME 04553
Office: (207) 563-3441
ceo@newcastlemaine.us

NEWFIELD

Norman Hutchins
637 Water St
West Newfield, ME 04095
Phone: (207) 793-4348
Cell: (207) 608-2544
newfieldceo@metrocast.net

NEWPORT

Albert Tempesta
Twn Ofc / 23 Water St
Newport, ME 04953
Phone: (207) 368-4410
info@newportmaine.net

NEWRY

Joelle Corey
422 Bear River Rd
Newry, ME 04261
Office: (207) 824-3123 ext 2
Cell: (207) 393-7705

NOBLEBORO

Stanley Waltz
133 Eugley Hill Rd
Nobleboro, ME 04555
Office: (207) 832-7351
Cell: (207) 634-5735
nobleboroceo@gmail.com

NORRIDGEWOCK

David Savage
16 Perkins St
Norridgewock, ME 04957
Office: (207) 634-2252

NORTH BERWICK

Matt Leconte
21 Main St
North Berwick, ME 03906
Phone: (207) 676-3353 opt 2

NORTH HAVEN

Ian Hopkins
PO Box 400
North Haven, ME 04853
Office: (207) 867-4433

NORTH YARMOUTH

Ben Scipione
10 Village Square
North Yarmouth, ME 04097
Office: (207) 829-3705 ext 206

NORTHFIELD

James Bradley
PO Box 263
Machias, ME 04654
Phone: (207) 255-8874

NORTHPORT

C. Toupie Rooney
60 Flanders Rd
Northport, ME 04849
Office: (207) 338-3819
Cell: (207) 322-2436
northportceo@gmail.com

NORWAY

Chris Bilodeau
19 Danforth St
Norway, ME 04268
Phone: (207) 739-7929
ceo@norwaymaine.com

OAKFIELD

Torry Lane
Phone: (207) 694-2370

OAKLAND

Nathan Smart
PO Box 187
Oakland, ME 04963
Phone: (207) 465-2842
Cell: (207) 649-4760
nsmart@oaklandmaine.us

OGUNQUIT

Tyler McOsker
23 School St
PO Box 875
Ogunquit, ME 03907
Phone: (207) 646-9326
ceoogt@townofogunquit.org

OLD ORCHARD BEACH

Rod Belanger
1 Portland Ave
Old Orchard Beach, ME 04064
Office: (207) 937-5638

Rick Haskell

Office: (207) 937-5615

OLD TOWN

David Russell
265 Main St
Old Town, ME 04468
Office: (207) 827-3965 ext 205

ORLAND

Luke Chiavelli
PO Box 67
Orland, ME 04472
Office: (207) 735-6428
lchiavelli@Rdrunner.com

ORONO

Patrick Estey
59 Main St
Old Town, ME 04468
Office: (207) 866-5051
estey@orono.org

ORRINGTON

Dean Bennett
1 Municipal Way
Orington, ME 04474
Office: (207) 825-3745 ext4
code@orrington.org

OTIS

Richard Leavitt
132 Otis Rd
Otis, ME 04605
Office: (207) 537-2211
Cell: (207) 949-6775
rk43@aol.com

OTISFIELD

Fred Collins
403 State Rte 121
Otisfield, ME 04270
Office: (207) 539-2664 ext 3
ceoofotisfield@myfairpoint.net

OWLS HEAD

Rodney Mason
224 Ash Point Rd
Owls Head, ME 04854
Office: (207) 594-7434
ceomason@owlsheadmaine.gov

OXFORD

Kirston Brown
126 King St
Oxford, ME 04270
Office: (207) 539-4431 ext 107
ceo@oxfordmaine.org

PALERMO

Darryl McKenney
Office: (207) 993-2467

PALMYRA

Travis Gould
4 Madawaska Rd
PO Box 6
Palmyra, ME 04965
Phone: (207) 924-4057

PARIS

33 Market Sq
So. Paris, ME 04281
Office: (207) 890-9590
ceo@parismaine.org

PARKMAN

Lance Johnson
771 State Hwy 150
Parkman, ME 04443
Phone: (207) 876-3730

PARSONSFIELD

Jesse Winters
634 North Rd
Parsonsfeld, ME 04047
Phone: (207) 625-4804
(207) 625-4558

PASSADUMKEAG

Dwight Tilton
34 Pleasant St
Passadumkeag, ME 04475
Office: (207) 732-5111

PATTEN

Bruce Hussey
Phone: (207) 554-9051

PEMBROKE

Andrew Snowman
PO Box 287
Pembroke, ME 04666
Office: (207) 726-2036
andrewsnowman57@gmail.com

PENOBSCOT

Bryce Farnham
1 Southern Bay Rd
Penobscot, ME 04476
Phone: (207) 701-8465
brycefarnham@gmail.com

PERRY

Allan Sutherland
PO Box 183
Eastport, ME 04631
Cell: (207) 904-8891
sutherlandallen952@yahoo.com

PERU

David Errington
148 Auburn Rd
Peru, ME 04290
Office: (207) 364-2666
Phone: (207) 562-8081

PHIPPSBURG

Leighton Rainey
1042 Main Rd
Phippsburg, ME 04562
Office: (207) 389-1088
codes@phippsburg.com

PITTSTON

Bruce Engert
38 Whitefield Rd
Pittston, ME 04345
Office: (207) 582-4438
codes@pittstonmaine.org

PLYMOUTH

Randy Hall
37 South Rd
Dixmont, ME 04932
Office: (207) 234-4006
randy_006@msn.com

POLAND

Scott Neal
1231 Maine St
Poland, ME 04274
Office: (207) 998-4604

PORTAGE LAKE

Margaret Pierce
73 Fox Hill Rd
Portage Lake, ME 04768
Office: (207) 554-0289
Home: (207) 554-0289
mpierce17@aol.com

PORTER

Dan Davis
Phone: (207) 256-4522
ceo@portermaine.org

PORTLAND

Doug Morin
389 Congress St, Room 315
Portland, ME 04101
Office: (207) 874-8705
drm@portlandmaine.gov

Duane Hanson

389 Congress St
Portland, ME 4101
Office: (207) 874-8707
dhanson@portlandmaine.gov

POWNAI

429 Hallowell Rd
Pownal, ME 04069
Office: (207) 688-4431
ceo@pownalmaine.org

PROSPECT

Luke Chiavelli
958 Bangor Rd
Prospect, ME 04981
Office: (207) 735-6428
lchiavelli@roadrunner.com

RANDOLPH

Greg Lumbert
121 Kinderhook St
Randolph, ME 04346
Home: (207) 592-7073
randolphceo@roadrunner.com

RANGELEY

Breck Parker
15 School St
Rangeley, ME 04970
Home: (207) 864-3188
ceo@rangeleyme.org

RAYMOND

Alex Sirois
401 Webbs Mills Rd
Raymond, ME 04071
Office: (207) 655-4742 ext 161
ceo@raymondmaine.org

READFIELD

Chip Stephens
8 Old Kents Rd
Readfield, ME 04355
Phone: (207) 685-3290
Cell: (207) 931-7689

RICHMOND

James Valley
26 Gardiner St
Richmond, ME 04357
Phone: (207) 737-4305 ext 205
ceo@richmondmaine.com

ROCKLAND

Adam Ackor
270 Pleasant St
Rockland, ME 04841
Office: (207) 594-0308
rocklandcode@rocklandmaine.gov

LOCAL PLUMBING INSPECTORS

ROCKPORT

Scott E Bickford

PO Box 186

W. Rockport, ME 04865

Office: (207) 236-0989

sbickford@rockportmaine.gov

ROME

Andrew Marble

8 Mercer Rd

Rome, ME 04963

Office: (207) 397-3293

ROXBURY

Richard Coulombe

145 Congress St

Rumford, ME 04276

Office: (207) 364-4576

Rcoulombe@rumfordme.org

RUMFORD

Richard Coulombe

145 Congress St

Rumford, ME 04276

Office: (207) 364-4576

rcoulombe@rumfordme.org

SABATTUS

190 Middle Rd

Sabattus, ME 04280

Phone: (207) 375-4331

ceo@sabattus.org

SACO

David Twomey

City Hall / 300 Main St

Saco, ME 04072

Office: (207) 284-6983

dtwomey@sacomaine.org

SANFORD

Jamie Cole

917 Main St, Ste 300

Sanford, ME 04073

Office: (207) 324-9145

SANGERVILLE

Lance Johnson

Phone: (207) 446-5459

SCARBOROUGH

Town Ofc / PO Box 360

Scarborough, ME 04074

Office: (207) 730-4040

Brian Dobson

PO Box 360

Scarborough, ME 04074

Office: (207) 730-4052

bdobson@scarboroughmaine.org

SEARSMONT

Frank Therio

PO Box 396

Stockton Springs, ME 04981

Phone: (207) 342-5411

SEARSPORT

Randy Hall

37 South Rd

Dixmont, ME 04932

Office: (207) 991-0117

Home: (207) 234-4006

randy_006@msn.com

SEBAGO

Brandon Woolley

406 Bridgton Rd

Sebago, ME 04029

Office: (207) 787-2457

SEBEC

Brian Turner

PO Box 41

Monson, ME 04464

Office: (207) 997-3287

copalt@myfairpoint.net

SEDGWICK

Duane Ford

719 N Sedgewick Rd / PO Box 40

Sedgwick, ME 04676

Phone: (207) 610-9544

Cell: (207) 359-2275

SHAPLEIGH

Mike Demers

Twn Ofc / PO Box 26

Shapleigh, ME 04076

Office: (207) 636-2844

ceo@shapleigh.net

SHIRLEY

Brian Turner

PO Box 147

Shirley, ME 04485

Home: (207) 997-3287

townofshirley@myfairpoint.net

SIDNEY

Keegan Ballard

2986 Middle Rd

Sidney, ME 04330

Phone: (207) 547-3340

(207) 441-5302

kballard@sidneymaine.org

SKOWHEGAN

Brian Belliveau

225 Water St

Skowhegan, ME 04976

Phone: (207) 474-6900

skowcode@skowhegan.org

SMITHFIELD

Hans Rasmussen

926 Village Rd

Smithfield, ME 04978

Phone: (207) 362-4772

smithfieldceo@gmail.com

SOMERVILLE

Arthur Strout

72 Sand Hill Rd

Somerville, ME 04348

Office: (207) 549-3828

ceo.lpi@somervillemaine.org

SOUTH BERWICK

Jeni McCabe

Twn Ofc / 180 Main St

S. Berwick, ME 03908

Office: (207) 384-3011

SOUTH BRISTOL

Joseph Rose

1268 Bristol Rd

Bristol, ME 04539

Phone: (207) 563-5270 ext 303

SOUTH PORTLAND

Scott Havu

PO Box 9422

S. Portland, ME 04106

Office: (207) 767-7603

shavu@southportland.org

SOUTH THOMASTON

PO Box 147

S. Thomaston, ME 04358

Phone: (207) 596-6584

SOUTHPORT

Jim Gagnon
PO Box 149
W. Southport, ME 04576
Office: (207) 633-3318

SOUTHWEST HARBOR

John Larson
PO Box 745
S.W. Harbor, ME 04679
Office: (207) 244-5404
Phone: (207) 244-7915
ceo@southwestharbor.org
codesouthwest@southwestharbor.org

ST ALBANS

Travis Gould
7 Water St
St. Albans, ME 04971
Phone: (207) 938-4568

ST GEORGE

Terry Brackett
3 School St
Tenants Harbor, ME 04860
Phone: (207) 372-6363

STANDISH

James Paul
175 Northeast Rd
Standish, ME 04084
Office: (207) 642-4571
jpaul@standish.org

STARKS

Lee Mayo
57 Anson Rd
Starks, ME 04911
Phone: (207) 696-8069
Cell: (207) 474-1575
townofstarks@gmail.com

STOCKTON SPRINGS

Toupie Rooney
217 Main St
Stockton Springs, ME 04981
Office: (207) 567-3404
codes@stocktonsprings.org

STONEHAM

Robert Folsom
22 Butters Hill Rd
PO Box 91
Stoneham, ME 04231
Office: (207) 928-2155
Cell: (207) 824-8065

STONINGTON

Matthew Betts
Twn Ofc / PO Box 9
Stonington, ME 04681
Office: (207) 367-2351 ext 11

STOW

Ron McAllister710 Stow Rd
Stow, ME 04037
Office: (207) 697-2007
Cell: (207) 925-6722
townofstow@fairpoint.net

STRONG

Thomas Marcotte
PO Box 806
Farmington, ME 04938
Home: (207) 684-4111

SULLIVAN

Michael Guntler
Phone: (207) 288-3545

SUMNER

Fred Collins
Phone: (207) 890-6256

SURRY

Darcel Winslow
Phone: (207) 667-5941

Bill Booth

Phone: (207) 667-5912
ceo@townofsurrymaine.com

SWANS ISLAND

Caitlin Trafton
PO Box 11
Swan's Island, ME 04685
Phone: (207) 951-4562
caitlintrafton@yahoo.com

SWEDEN

Peter Gordon
147 Bridgton Rd
Sweden, ME 04040
Phone: (207) 298-6248

THOMASTON

Rene Dorr
Twn Ofc / 170 Main St
Thomaston, ME 04861
Office: (207) 354-6107 ext 110
Cell: (207) 975-1534
bwasson@thomastonmaine.gov

THORNDIKE

Charlie Porter
PO Box 10
Thorndike, ME 04986
Phone: (207) 948-6325

TOPSHAM

Thomas Lister
100 Main St
Topsham, ME 04086
Office: (207) 725-1723
tlister@topshammaine.com

TREMONT

John Larson
Phone: (207) 244-7204
codeenforcementofficer@
tremont.maine.gov

TRENTON

Angela Chamberlin
59 Oak Pt Rd
Trenton, ME 04605
Office: (207) 667-7207

TROY

Randy Hall
Office: (207) 991-0117

TURNER

Ross Gauge
11 Turner Center Rd
Turner, ME 04282
Office: (207) 225-3414
Cell: (207) 754-3319
ceo@megalink.net

UNION

Grant Watmough
567 Common Rd
Union, ME 04862
Office: (207) 785-3658
Cell: (207) 754-3313
codeenforcement@union.maine.gov

UNITY

David Schofield
10 Patterson Ridge Rd
Knox, ME 04986
Office: (207) 568-3547
Home: (207) 568-3547

VASSALBORO

Jason Lorrain
Phone: (207) 872-2826

LOCAL PLUMBING INSPECTORS

ceo.lpi.washingtonmaine@gmail.com

VEAZIE

Andy Fish

1084 Main St
Veazie, ME 04401
Office: (207) 947-2781

VERONA ISLAND

Luke Chiavelli

16 School St
PO Box 1940
Verona Island, ME 04416
Office: (207) 735-6428

VINALHAVEN

Faye Grant

19 Washington School Rd
Vinalhaven, ME 04863
Phone: (207) 863-2168

WALDO

David Schofield

629 Waldo Station Rd
Waldo, ME 04915
Phone: (207) 322-7365

WALDOBORO

Mark Stultz

1600 Atlantic Hwy
Waldoboro, ME 04572
Office: (207) 832-5369
ceo@waldoboromaine.org

WALES

Alan Plummer

175 Centre Rd
Wales, ME 04280
Office: (207) 375-8881
Cell: (774) 404-3601
walesceolpi@roadrunner.com

WARREN

Melody Sainio
167 Western Rd
Warren, ME 04864
Office: (207) 273-2421
ceo@warrenmaine.org

WASHBURN

Adam Doody

Twn Ofc / 1287 Main St
Washburn, ME 04786
Phone: (207) 455-8485

WASHINGTON

David Studer

Cell: (207) 845-2897

WATERBORO

Mike Gilpatrick

24 Townhouse Rd
East Waterboro, ME 04030
Office: (207) 247-6166 ext 120
ceo@waterboro-me.gov

WATERFORD

John Bell

366 Valley Rd
Waterford, ME 04088
Office: (207) 583-4403
Cell: (207) 595-4660
ceo@waterfordme.org

WATERVILLE

Daniel Bradstreet

1 Common St
Waterville, ME 04901
Office: (207) 680-4231
dbradstreet@waterville-me.gov

WAYNE

Chip Stephens

PO Box 400
Wayne, ME 04284
Office: (207) 685-4983
Cell: (207) 395-6414
ceolpi@waynemaine.org

WELD

Michael Stephenson

Phone: (207) 585-2348
ceo@weld-maine.org

WELLS

Jodine Adams

208 Sanford Rd
Wells, ME 04090
Office: (207) 646-5187
jadams@wellstown.org

WEST BATH

Johnathan Beane

219 Foster's Point Rd
West Bath, ME 04530
Phone: (207) 443-4342
codes@westbathmaine.gov

WEST GARDINER

Casey Peacock

318 Spears Corner Rd
West Gardiner, ME 04345
Phone: (207) 441-6864

WESTBROOK

Brian Stetson

2 York St
Westbrook, ME 04092
Office: (207) 854-0638
Cell: (207) 653-1189
bstetson@westbrook.me.us

David Finocchietti

2 York St
Westbrook, ME 04092
Office: (207) 854-0638
Cell: (207) 210-2688
dfinocchietti@westbrook.me.us

WESTPORT

Gary Richardson

6 Fowles Point Rd
Westport, ME 04578
Office: (207) 882-6357
grichardson1595@gmail.com

WHITEFIELD

Arthur C Strout

36 Town House Rd
Whitefield, ME 04353
Office: (207) 458-2154
Phone: (207) 445-3263

WHITING

James Bradley

PO Box 521
E. Machias, ME 04630
Office: (207) 255-8874

WHITNEYVILLE

James Bradley

PO Box 521
E. Machias, ME 04630
Office: (207) 255-8874

WILTON

Gary Judkins

158 Weld Rd
Wilton, ME 04294
Office: (207) 645-4961
ceo@wiltonmaine.org

WINDHAM

Jon Rioux

Town Ofc / 8 School Rd
Windham, ME 4062
Office: (207) 894-5900 ext 6112

WINDSOR

Arthur C Strout
PO Box 57
Windsor, ME 04363
Office: (207) 445-3263
Home: (207) 441-9885

WINN

Jerry Davis
Phone: (207) 736-7111

WINSLOW

Chris Lyons
114 Benton Ave
Winslow, ME 04901
Phone: (207) 872-2776
clyons@winslow-me.gov

WINTER HARBOR

Millard Billings
Office: (207) 963-2235

WINTERPORT

Jackie Robbins
20 School St / PO Box 559
Winterport, ME 04496
Office: (207) 223-5055
Cell: (207) 852-1840
bonaire4robbins@gmail.com

WINTHROP

Mark Arsenaault
17 Highland Ave
Winthrop, ME 04364
Phone: (207) 377-7200 ext 7

WISCASSET

Bruce Engert
51 Bath Rd
Wiscasset, ME 04578
Office: (207) 882-8200 ext 7
codes@wiscasset.org

WOODLAND

Bruce Hussey
Office: (207) 498-6133

WOODSTOCK

Kingston Brown
kingston.brown@gmail.com

WOOLWICH

Chris Wilcoxson
13 Nequasset Rd
Woolwich, ME 04579
Office: (207) 442-7094
codes@woolwich.us

YARMOUTH

Nicholas Ciarimboli
200 Main St
Yarmouth, ME 04096
Office: (207) 846-2401
nciarimboli@yarmouth.me.us

YORK

Harry Norton
186 York St
York, ME 03909
Office: (207) 363-1002

Kathryn Newell

186 York St
York, ME 03909
Office: (207) 363-1002
Cell: (207) 451-5082
knewell@yorkmaine.org

Aaron Beauregard

186 York St
York, ME 03909
Office: (207) 363-1002

TOWNSHIPS:

You can locate an LPI for Townships at <http://www.maine.gov/dhhs/mecdc/environmental-health/plumb/lists.htm>



BLUE MONSTER[®] **Supports** **the Maine** **PHCC** **and their** **Tradesmen!**



Thread Seal Compounds and Tapes



Drain Banger



Velocity[™]
Tankless Water Heater Flush



Citrus Scrubs



Arctic Armor Thermal Shield



Compression Seal Tape



Professional Grade Abrasives



Advantage Closet Bolts



Whizz Banger[™]
Urinal Cleaner



Brushing Tools



MILL-ROSE
Clean-Fit Products

Now Proudly Represented by:



JOHN STACK SALES COMPANY

www.stacksales.com

Toll-free Phone: 888-466-4328 • Toll-Free Fax: 866-634-7737

BUYERS GUIDE

(Listed in Alphabetical order)

AMERICAN NATIONAL INSURANCE

Service Provider

John Heller

jheller@american-national.com

Tel: (207) 563-5200

434 Main Street

PO Box 280

Damariscotta, Maine 04543

Business, Life, Pension, 401(k), Disability

Associate Member

BANGOR PIPE & SUPPLY INC.

Wholesaler

American Standard, Oasis, Pex, Suntemp Baseboard, Granby, Myers Pumps, Charlotte Pipe & Fittings, State Water Heaters, Riobel Faucets, Amtrol, Biasi Boilers, Heat Flo, IBC Boilers, Radiant Heat Design & Layout, Smith CI Boilers, Biasi Radiant Panels, Penzotti Panel Radiators, Riobel IBC Indirect Tanks, Dayton SS Sinks, Sloan, Taco Pump, Apollo Press Fittings, Grunfo Pumps

Outside Sales: Chris Grover

Email: chris@bangorpipe.com

69 Farm Rd, Bangor 55 Foster St / Ellsworth

Tel: (800) 439-7473 Bangor

Tel: (800) 540-5346 Ellsworth

Associate Member PHCC of Maine

THE BELL/SIMONS CO

Wholesaler

Full line wholesaler of heating, air conditioning, radiant, ventilation, plumbing, and refrigeration. Biasi, Utica, New Yorker, Reznor, Miller, Mitsubishi, Frigidaire, Unico, Rehau, Duc-Pac, Lasco, Mansfield, Copeland & Larkin, Crown Boiler, Nordyne, Heat-Flo Tanks, Amtrol, Rheem Heaters, Weil Mclain Boilers, Haydon Baseboard, Ruud Residential & Commercial Products.

62 Academy St / Auburn, ME 04211

Tel: (207) 786-0129 • Fax: (207) 786-2462

470 Odlin Rd / Bangor, ME 04401

Tel: (800) 438-4756 • Fax: (207) 947-1539

29 Landry St / Biddeford, ME 04005

Tel: (207) 284-5975 • Fax: (207) 284-9038

97 Parker St / Brewer, ME 04412

Tel: (800) 437-8469 • Fax: (207) 989-6265

75 Wyman Rd / Hancock, ME 04640

Tel: 297-664-1904 • Fax: (207) 664-1907

373 Riverside Industrial Pkwy / Portland, ME 04103

Tel: (800) 438-4757 • Fax: (207) 797-7147

87 River Rd / Sanford, ME 04073

Tel: (207) 490-2244 • Fax: (207) 490-2299

56 Airport Rd / Waterville, ME 04901

Tel: (800) 437-8466 • Fax: (207) 872-2418

Associate Member PHCC of Maine

COOPER NEW ENGLAND SALES

Manufacturer's Representative

Liberty Pumps, Oasis Bath, Viega Pex

Scott Cooper

info@c-nes.com

Tel: (203) 720-7161

649 Amity Rd, Suite 105

Bethany, CT 06524

Associate Member PHCC of Maine

DAN DAVIS SALES

Manufacturer's Representative

Amtrol, Boyertown Furnace, Caleffi Hydronic Solutions, Carlin/Hydrolevel Company, Charter Plastics, CT Piping/Pestan Pipe, Kalas Wire, New Yorker Boilers, QHT-Biasi, Radiators, Watersoft, Axiom, Reimers, Columbia, Myson

Paul Levesque, Mike Levesque, Evan Levesque

PO Box 567 / Springvale, ME 04083

Tel: (800) 410-8700

Fax: (207) 324-2217

Email: info@dandavissales.com

Tech Support: (800) 410-8700

Associate Member PHCC of Maine

DAVENPORT ASSOCIATES, INC.

Manufacturer's Representative

Acorn, Bemis, Bradley, Bradford White, Charlotte, Chronomite, Controls, Elmdor, ISE, Jaclo, Jay R. Smith, Jomar, MrSteam, Murdock, Niagara, Oatey, Sterling HVAC, T&S, OmegaFlex, Whitehall, Woodford

**DAVENPORT ASSOCIATES, INC.
(CONT.)**

Billy Forcier, Ryan Davenport, Steve Lally

75 Parker St / Wallingford CT, 06492

Tel: (203) 265-2389

Email: billy@davenportassociates.com;

slally@davenportassociates.com;

ryan@davenportassociates.com

www.davenportassociates.com

Associate Member PHCC of Maine

DAVID GOODING, INC.

Manufacturer's Representative

NIBCO, Navien

173 Spark St / Brockton, MA 02302

Tel: (508) 894-2000

Email: inside@goodingd.com,

chrisg@goodingd.com

Tech Support: (800) 836-3441

www.goodingd.com

DYSON ASSOC., INC.

Manufacturer's Representative

Product Lines: Columbia Boilers, CPS, JJM, Utica Boilers, Utica Heating, Pennco, EMI

191 Kenwood Dr / New Britain, CT 06052

Tel: (877) 890-2983

Jennie Perferuo: (860) 992-5663

Fax: (860) 225-9268

Email: jennie@dysonassoc.com

www.dysonassoc.com

Tech Support:

andrew@dysonassoc.com (401) 601-5128

After Hours Emergency Contact:

Dean Santomango (207) 300-5288

dean@dysonassoc.com

Associate Member PHCC of Maine

**EDOS MANUFACTURERS'
REPS., INC**

Manufacturer's Representative

Honeywell, Maax, Testo, Noble, Velocity Boilers

Plumbing: Anthony Webber

8B W State St / Granby, MA 01033

Cell: (207) 233-7363

Email: anthony@edosonline.com

Heating: Darren Webber

8B W State St / Granby, MA 01033

Cell: (207) 409-5787

Fax: (207) 929-3617

Email: darren@edosonline.com

Main Office: (413) 467-9151

Fax: (413) 467-7824

www.edosonline.com

Associate Member PHCC of Maine

EFFICIENCY MAINE

Service Provider

Rebates for heat pump water heaters, ECM heat pumps, and other types of high efficiency equipment.

Find out more at efficiencymaine.com. Learn how

to get thousands of dollars of rebates for your customers.

PO Box 219 / Brunswick, ME 04011

Tel: (866) 376-2463

info@efficiencymaine.com

www.efficiencymaine.com

EMERSON-SWAN

Manufacturer's Representative

Heating, Plumbing, HVAC and Showroom, 40+ Lines

Frank Melberg, Lloyd Benjamin, and Tom Protasewich

300 Pond St / Randolph, MA 02368

Tel: (781) 986-2000

Fax: (781) 986-2028

Email: info@emersonswan.com

www.emersonswan.com

Associate Member PHCC of Maine

F.W. WEBB CO

Wholesaler

The largest wholesale distributor of plumbing, heating, HVAC, LP gas, refrigeration, pipe, valves and fittings in the Northeast. Thirteen wholesale locations across Maine offer an extensive inventory of products and 16 areas of expertise, including process controls, water works, industrial PVF and more.

138 Leighton Rd / Augusta, ME 04430

Tel: (207) 623-2521

Fax: (207) 622-2533

After Hours Emergency Contact: (207) 530-2639

General Manager: Nick Pelletier

Alphabetical Listing of

F.W. WEBB CO (CONT.)

22 Landry St / Biddeford, ME 04005

Tel: (207) 282-7558

Fax: (207) 282-0299

After Hours Emergency Contact: (207) 468-2998

General Manager: Greg Thompson

420 Main St / Caribou, ME 04736

Tel: (207) 498-2526

Fax: (207) 498-2137

After Hours Emergency Contact: (207) 484-8119

General Manager: Justin Gelinias

9 Buttermilk Rd / Ellsworth, ME 04605

Tel: (207) 667-9322

Fax: (207) 644-0201

After Hours Emergency Contact: (207) 904-7585

General Manager: Justin Gelinias

20 Webb Dr / Hampden, ME 04444

Tel: (207) 947-6905

Fax: (207) 947-8211

After Hours Emergency Contact: (207) 286-4569

General Manager: Justin Gelinias

9 Lexington St / Lewiston, ME 04240

Tel: (207) 784-4575

Fax: (207) 784-4205

After Hours Emergency Contact: (207) 810-2474

General Manager: Nick Pelletier

6 Highland Dr / Oakland, ME 04963

Tel: (207) 716-1456

Fax: (207) 872-0010

After Hours Emergency Contact: (207) 692-3778

General Manager: Nick Pelletier

29 Industrial Dr / Oakland, ME 04963

Water Works & Industrial PVF Divisions

Tel: (207) 873-2111

Fax: (207) 300-2509

After Hours Emergency Contact: (207) 649-3605

General Manager: Nick Pelletier

22 Merrill Dr / Rockland, ME 04841

Tel: (207) 594-6200

Fax: (207) 594-9185

After Hours Emergency Contact: (207) 975-3092

General Manager: Justin Gelinias

150 Postal Service Way / South Portland, ME 04106

Tel: (207) 722-8364

Fax: (207) 773-4571

After Hours Emergency Contact: (207) 756-5719

General Manager: Greg Thompson

6 Bull Rock Bridge Rd / West Bath, ME 04530

Tel: (207) 442-7990

Fax: (207) 442-8377

After Hours Emergency Contact: (207) 315-5985

General Manager: Nick Pelletier

3 Danielle Dr / Windham, ME 04062

Tel: (207) 892-5504

Fax: (207) 892-5507

After Hours Emergency Contact: (207) 332-9325

General Manager: Greg Thompson

37 Heywood Rd / Winslow, ME 04901

Process Controls Division

Tel: (207) 873-7741

Fax: (207) 873-2945

After Hours Emergency Contact: (207) 841-5722

General Manager: Nick Pelletier

Associate Member PHCC of Maine

FEDERATED INSURANCE

Service Provider

Property & Liability, Worker's Compensation,
Association Risk Management Services

Jon Medo, Field Manager

121 E. Park Square / PO Box 328

Owatonna, MN 55060

Tel: (800) 533-0472

Fax: (507) 455-7840

Client Contact Center (888) 333-4949

jwmedo@fedins.com

www.federatedinsurance.com

Associate Member PHCC of Maine

FERGUSON ENTERPRISES

Wholesaler

Full line plumbing, heating, HVAC wholesaler.

Kohler and American Standard plumbing products.

State commercial/residential water heaters, oil/gas fired boilers by Pensotti, U. S. Boiler, Viessman, and Weil-McLain. Trane, American Standard, Mitsubishi, Goodman, LG, GE, and Durastar HVAC.

172 St. John St / Portland, ME 04104

Tel: (800) 492-0817 / (207) 773-4755

Fax: (207) 772-2957

9 Redlon Rd / Bath, ME 04530

Tel: (800) 442-6720 / (207) 443-5592

Fax: (207) 443-1651

5 Sposedo Rd / Windham, ME 04062

Tel: (207) 892-0290

Fax: (207) 892-0354

**FERGUSON ENTERPRISES
(CONT.)**

293 Abby Rd / Manchester, NH 03103
Tel: (603) 669-8100 / (800) 258-9746
Fax: (603) 669-4723

118 Northeastern Blvd / Nashua, NH 03062
Tel: (603) 589-7580
Fax: (603) 518-1896

126 Bridge St / Portsmouth, NH 03801
Tel: (800) 582-0860 / (603) 436-3550
Fax: (603) 436-4460

5 Karen Dr./Westbrook, ME 04092
Tel: 207-560-6870

S. G. Torrice – HVAC

115 Heritage Ave./Portsmouth, NH 03801
Tel: 603-373-6951

S. G. Torrice – HVAC

2 Keller St./Manchester, NH 03103
Tel: 603-945-1490

S. G. Torrice – HVAC

24 Flagstone Dr./Hudson, NH 03051
Tel: 800-335-4822

S. G. Torrice – HVAC

Associate Member PHCC of Maine

FIA, INC

Manufacturer's Representative

Bell & Gossett, Domestic Pump, Hoffman Specialty,
McDonnell & Miller, Laing, Envirosep Fluid Systems, Flex-
Hose, Flow Conditioning, Lochinvar, Tekmar Controls,
Webstone Valve, Boiler Mag, Wessels Company, Holby
Valve, Preso, Kadant-Johnson Liquid-Mover, Centrotherm
Venting

Mark Cunniff, (339) 227-0472;

Kim Garrant, (603) 540-5624

7 Sixth Rd / Woburn, MA 01801

Tel: (781) 938-8900

Fax: (781) 933-3965

Email: custsrv@fiainc.com

www.fiainc.com

Tech Support: (800) 423-7187

Associate Member PHCC of Maine

FUTURA SALES

Manufacturer's Representative

Delta Faucet, Mansfield, Jones Stephens, Schier, Striem,
Whitlam, Red White Valve, General Wire, Easy Heat,

CLC, Hydro Systems, Native Trails, Newport Brass,
Steamist, Strom Living

Kenneth Wilensky

PO Box 1634 / Framingham, ME 04938

Tel: (508) 479-5585

kenny@futuresales.com

**THE GRANITE GROUP SINK &
SPOUT SHOWROOMS**

Wholesaler

Kohler, Mitsubishi, State Water Heaters, Rinnai, Bosch
Gerber, Delta, Moen, Weil McLain, Viega and Uponor

James Currie, Branch Mgr.

Jeff Claffin, Outside Sales 207-650-1032

Josh Metivier, Outside Sales 207-478-9534

331 Warren Ave/Portland, ME 04103

Tel. 207-514-1280

Email: jcurrie@thegrانيتgroup.com

After Hours Emergency: 207-400-8339

Nick Handville, Branch Manager

Jeff Claffin, Outside Sales 207-650-1032

Steve Metivier, Outside Sales 207-578-2759

155 Rumery St South Portland, ME 04106

Tel. 207-321-0080

Email: nhandville@thegrانيتgroup.com

After Hours Emergency: 207-321-0089

Jeremy Hebert, Branch Manager

Laddie Stevens, Outside Sales 207-400-1266

660 Minot Ave/Auburn, ME 04210

Tel. 207-514-1280

Email: jhebert@thegrانيتgroup.com

After Hours Emergency: 207-514-1289

Michael Doyon, Branch Manager

Joshua Metivier, Outside Sales 207-478-9534

380 Lincoln St/Lewiston, ME 04240

Tel. 207-333-4340

Email: mdoyon@thegrانيتgroup.com

After Hours Emergency: 207-333-4349

Kevin Spaulding, Branch Manager

Laddie Stevens, Outside Sales 207-400-1226

662 Wilton Road/Farmington, ME 04938

Tel. 207-305-1810

Email: kspaulding@thegrانيتgroup.com

After Hours Emergency: 207-305-1819

Alphabetical Listing of

Dan Dupuis, Branch Manager
Rick Howard, Outside Sales 207-745-6762
32 Thatcher St/Bangor, ME 04401
Tel. 207-300-2310
Email: ddupuis@thegrانيتgroup.com
After Hours Emergency: 207-300-2319

Ales Curtis, Branch Manager
Frank Foss, Outside Sales 207-852-4274
314 State St/Augusta, Me 04330
Tel. 207-405-2010
Email: acurtis@thegrانيتgroup.com
After Hours Emergency: 207-405-2019
Associate Member PHCC of Maine

HEAT-FLO

Manufacturer
HEAT-FLO Indirect Water Heaters, Hot Water
Booster / Storage Tanks, Multi-Energy Tanks,
Hydronic Buffer Tanks, High Output Indirect Water
Heaters

Guy Woollard
15 Megan Court / PO Box 612
Uxbridge, MA 01569
Tel: (508) 930-6448
Email: sales@heat-flo.com, gwoollard@heat-flo.com
www.heat-flo.com
Associate Member PHCC of Maine

HEWS COMPANY, LLC

Manufacturer's Representative
Reading, Maintainer, DownEaster, Duramag,
Thieman, Maxon, Hiab, Moffett, Muncie,
WeatherGuard, Hews Taskmaster Custom Bodies

**Brian Guillerault, Laura Pralicz, Dave Gain,
Ben Bruns, Ron Cripps**
190 Rumery St / South Portland, ME 04106
Tel: (207) 767-2136
Fax: (207) 767-5381
Email: parts@hewscoco.com, sales@hewscoco.com
www.hewscoco.com
Tech Support: Dave Gain, Ron Cripps, Ben Brans,
Laura Pralicz

HOMANS ASSOCIATES

HVAC Distributor
Mitsubishi, Bryant, Johns Manville

Linda Wedge, Kevin McCormick, Caton Tompkins
111 C Pinetree Industrial Pkwy / Portland, ME 04103
Tel: (800) 922-9554 / (207) 310-3908
Fax: (207) 874-0560
Email: ctompkins@homans.com
68 Carey Dr / Hamden, ME 04444
Tel: (207) 945-6629
www.homans.com
Associate Member PHCC of Maine

IAPMO (INTERNATIONAL ASSOCIATION OF PLUMBING AND MECHANICAL OFFICIALS)

Service Provider
Publishes plumbing and mechanical codes
and standards. Provides third party testing and
certification of plumbing products and other
building materials. Provides ASSE 5000 Backflow
Certification.

Peter Kelly, Field Service Director
141 North St / Weymouth, MA 02191
Tel: (909) 224-2198
Email: peter.kelly@iapmo.org
www.IAPMO.org
Associate Member PHCC of Maine

J & K SALES ASSOCIATES

Manufacturer's Representative
Bosch, Nupi, Stanley Black and Decker (Lennox,
DeWalt, Irwin) Boshart Industries, Calefactio, M&G
DuraVent, K-Flex, Oatey SCS (Cherne, Hercules,
Dearborn Brass, Harvey), Turbo Torch, Walraven,
Spears, Miro Industries, Mifab, QuickFitting

Brian Inserra, Sales Director
101 A East Industrial Park Dr / Manchester, NH 03109
Tel: (800) 654-0415 / (603) 860-8016
Fax: (603) 625-2842
Email: binserra@jandksales.com
www.jandksales.com
Tech Support: Ken Lajoie, Bo Skinner (603) 626-1909
Associate Member PHCC of Maine

J.H. POKORNY ASSOCIATES LLC

Manufacturer's Representative
Sloan Valve, Leonard Thermostatic Valves, Oasis
electric water coolers, Metcraft stainless steel
plumbing fixtures, Guardian Equipment Co., Georg
Fischer acid pipe, Karp access doors and Kaldewi,
Big Dipper, EVAC, UVPure, Water Saver
1502 Providence Highway / Norwood, MA 02062
Tel: (781) 762-2661

Fax: (781) 762-5949
Email: jeffh@jhpokorny.net
www.jhpokorny.net

Associate Member PHCC of Maine

JOHN STACK SALES CO.

Manufacturer's Representative

ALRO, Argo, Automag, Beacon Morris, Laars Residential and Commercial, Maid- O-Mist, Mill Rose/Blue Monster, Canfield Solder, Thermo-Dynamics Boilers, Koch Filter, Mestek, Western Pottery, Zilmet

Gary Stack, Richard Charland, Dan Caldwell, Brian Yurch, Karen Pokorny

Corporate Headquarters:

575 Wyoming Ave, Suite A / Wyoming, PA 18644
Tel: 1 (888) 466-4328
Fax: 1 (866) 634-7737

Tech Support: info@stacksales.com

Associate Member PHCC of Maine

JOHNSTONE SUPPLY

Wholesaler

One stop shop, with a variety of options in unitary and specialty equipment, repair and replacement parts, and maintenance supplies for residential, light commercial, refrigeration and facilities maintenance.

Shawn Buck, HVAC Business Development Mgr.

30 Carey Circle / Hampden, ME 04444

Tel: (207) 561-7032

shawn.buck@johnstonesupply.com

Associate Member PHCC of Maine

K ROSS CO.

Manufacturer's Representative

Aquarius Bathware, Renovative Bath Systems, Comfort Designs, Filtrine Drinking Fountains, Intersan by Aqua Design, Hydrotek, Isimet, Advance Tabco, MAPA Products, Rockford Separators, General Partitions Toilet Compartments, Elcoma, Schott/Kimax, Kusel Equipment, Britex, Pro Vent Systems, The Clam, KR Specialties

Kevin Ross, Jeremy Ross, Matthew Ross, Ellen Lansing, Michelle Pratt

P.O. Box 162 / Kingston, MA 02364

Tel: (781) 422-2273

Fax: (781) 422-0128

Email: sales@krossco.com

www.krossco.com

Associate Member PHCC of Maine

MAGIC CARPET CLEANING & RESTORATION

Service Provider

Carpet & upholstery cleaning, emergency water restoration, mold remediation, thawing of frozen water and septic lines.

Tel: (207) 767-1359

info@MagicCCR.com

www.MagicCCR.com

Associate Member PHCC of Maine

MAINE NATURAL GAS

Energy Supplier

Natural gas to homes and businesses

Paul Wild

9 Industrial Pkwy, Brunswick, ME 04011

Tel: (207) 729-0420

pwild@mainenaturalgas.com

Associate Member PHCC of Maine

MEMA TECHNICAL EDUCATION CENTER

HVAC Training Facility

Maine Energy Marketer's Association

25 Greenwood Rd / Brunswick, ME 04011

Tel: (888) 863-3753

www.mtec4me.com

Associate member PHCC of Maine

MESSER

Truck Equipment

Adrian Steel, Prime Design, DECKED, CargoGlide van equipment. SpaceKap and BrandFx composite caps. Knapheide, Eby, and BrandFX service bodies, Switch-n-Go hoists and detachable bodies.

Tim Cook

170 Warren Ave / Westbrook, ME 04092

tim@messerte.com

Tel: (207) 854-9751 Sales, Service, Parts

www.messertruckequipment.com

METROPOLITAN PIPE & SUPPLY

Wholesaler

Metropolitan Pipe is a master distributor of a wide range of Plumbing, Heating, PVF and Industrial Supplies - serving as your "one stop shop". Our services include free delivery, pipe fabrication (cutting/threading/grooving), online ordering and VMI and much more.

**METROPOLITAN PIPE & SUPPLY
(CONT.)**

Bill Sloan

slobil@metpipe.com

Tel: (617) 492-6400

MA: 30 Innerbelt Road, Unit 1 Somerville, MA 02143

Tel: (617) 492-6400

NH: 100 West Road Portsmouth, NH 03801

Tel: (603) 436-1400

Associate Member PHCC of Maine

MILWAUKEE TOOL

Manufacturer

Power Tools, Accessories, Hand Tools, Light Equipment, Batteries, Cordless Technology, PPE/Safety Products, Cordless Lighting

Michael Marcusiano

1150 Forbes St / New Bedford, MA 02745

Tel: (774) 218-8578

Email: michael.marcusiano@milwaukeetool.com

Customer Service: 1-800-SAWDUST

Associate Member PHCC of Maine

MOEN, INC.

Manufacturer's Representative

Residential and Commercial Faucets, T&S Valves and Sinks, CSI Accessories, CFG Faucets, Garbage Disposals

Billie Senzek

Tel: (603) 490-2612

Email: billie.senzek@moen.com

253 Al Moen Dr, N.Olmstead, NH

www.moen.com

Tech Support: (800) 289-6636

Associate Member PHCC of Maine

MRA LIMITED

Manufacturer's Representative

121 Phenx

Cranston, RI 02920

Tom Rayco

Tel: (401) 864-5235

trayco@mralimited.com

PAPE CHEVROLET

Car & Truck Dealership

425 Westbrook St / South Portland, ME 04106

Tel: (207) 775-6111

Associate Member PHCC of Maine

PENDLETON ASSOCIATES

Manufacturer's Representative

Turbomax Heat Exchangers, Alt Heat Exchangers, Electric Boilers

85 Sanrico Drive

Manchester, Connecticut 06045

Brad Pendleton, Rich McCarthy, Doug Joyce

Tel: (800) 536-4114

After hours support: (617) 877- 8434

Brad Pendleton, brad@pendletonassoc.com

THE PORTLAND GROUP

Wholesaler

Kohler, Sterling, Gerber, Duravit, Ultra Bath, Aker, Grohe, Delta, HTP, IBC, Viessmann, Munchkin, Pensotti, Concord, Zoomlock, Specialty Tools, Viega Pro Press, Mega Press, Uponor, First Commpany hydro-air, DeHoust double-wall oil tanks, Modine unit heaters, Space Pak high velocity air conditioning, Fujitsu ductless, Diablo, Milwaukee, Taco

Jeff Golojuch, Br. Manager; Kevin Brady, Outside Sales; Tim Burton, Outside Sales; Ingrid Gerena and Natallie St. Louis, Showroom

91 Industrial Park Rd / Saco, Maine 04072

Tel: (207) 283-8787

Fax: (207) 283-4848

www.theportlandgroup.com

Tech Support: Dick Mailhot, (603) 647-6090;

Joe Valley, (401) 273-3045

After Hours Emergency Contact:

Jeff Golojuch, (207) 400-9729;

David Simard, (207) 229-2321

Associate Member PHCC of Maine

QHT, INC.

Manufacturer

Biasi Boilers, Firebird Boilers, Ecostyle Radiant Panels

Jim Quincy, President; Keith Hnatow, Technical Director

3560 Lafayette Rd, Building 2, Unit A

Portsmouth, NH 03801

Tel: (603) 334-6400

Fax: (877) 334-6401

Email: info@qhtinc.com

www.qhtinc.com

Tech Support: (800) 501-7697

Associate Member PHCC of Maine

REHAU**Manufacturer**

Globe Pexa Manufacturing, specializing in Radiant Heating & Cooling, Plumbing, Pre-Insulated PEX, and Geo systems.

Timothy Lovell

Timothy.lovell@rehau.com

Tel: (603) 952-1768; Office: (800)297-6371

Fax: (800)298-8914 | www.na.rehau.com

14525 MN 7, Suite 328

Minnetonka, Minnesota 55345

R.W. BECKETT**Manufacturer**

Conversion Gas Burners, Oil Burners, Safety Controls, Oil Tank Equipment, Oil Filters, Commercial and Residential

Mary Hall

PO Box 1289

Elyria, OH 44036

Tel: (800) 645-2876 (Main Office)

Cell: (617) 894-0236

Email: mhall@beckettcorp.com

Tech Support: (800) 645-2876

After Hours: (781) 910-4148

www.beckettcorp.com

Associate Member PHCC of Maine

RHEEM WATER HEATING**Manufacturer**

Water heater tanks, pump-on-demand combination boilers, heat pump hot water heaters

Harry Bedigan

Tel: (207) 415-9427

harry.bedigan@rheem.com

1100 Abernathy Rd Suite 1700 / Atlanta GA 30328

Tel: (800) 621-5622

Email: www.rheem.com/contact

www.rheem.com

Tech Support: (800) 432-8373

RIDGID**Manufacturer**

Drain cleaning tools, diagnostics, locating, press tools

John Rutberg

400 Clark St / Elyria, OH 44035

Tel: 1 (800)-4-RIDGID

Email: rtccustomerservice@emerson.com

www.ridgid.com

Tech Support: (800) 519-3456

RINNAI**Manufacturer**

Water heater and heating equipment

Michael Dupuis

180 International Dr / Peachtree City, GA 30269

Tel: (207) 806-9207

Email: mdupuis@rinnai.us

www.rinnai.us

RST THERMAL**Manufacturer's Representative**

Fast Pipe, Everstand, Unico, Renew Aire, Hisense

372 University Ave / Westwood, MA 02090

Tel: (781) 320-9910

Fax: (781) 320-9906

Email: mehickey@rstthermal.com

www.rstthermal.com

Tech Support: Dylan Troth, dylan@rstthermal.com

Sales Support: Alex Troth, alex@rstthermal.com

Associate Member PHCC of Maine

RUNTAL NORTH AMERICA**Manufacturer**

Runtal Radiators and towel warmers

Jon Wiberg

187 Neck Rd / Ward Hill, MA 01835

Tel: (800) 526-2621

Fax: (978) 372-7140

www.runtalnorthamerica.com

Tech Support: Jon Wiberg, (603) 770-2078

After Hours Emergency Contact: Jon Wiberg, (603) 770-2078

Associate Member PHCC of Maine

SUMMIT NATURAL GAS**Energy Supplier**

Natural gas provider to homes and businesses

Matt Jacobson, mjacobson@summitnaturalgas.com

Chrisara Smith, csmith@summitnaturalgas.com

442 Civic Center Dr, Suite 425 / Augusta, ME 04330

Tel: (800) 909-7642 / Fax: (207) 621-8000 ext 6

Tech Support: (207) 621-8000 ext 6

solutions@summitnaturalgas.com

www.summitnaturalgas.com

After Hours Emergency Contact:

1 (800) 883-3181

Associate Member PHCC of Maine

**SWEENEY ROGERS
GERAGHTY, INC.**

Manufacturer's Representative

Weil McLain, Fujitsu, TJernlund, Adey, Pro 1,
Vaughn, Noritz, Electro Industries, Airex

250 Richmond St / Raynham, MA 02767

Tel: (508) 822-3939

Fax: (508) 822-0553

Email: sales@srgirep.com

www.srgirep.com

Tech Support: (973) 575-0381 (Fujitsu)

Associate Member PHCC of Maine

SYMMONS

Manufacturer

Shower Valves, Faucets and Thermostatic
Mixing Valves

Dale Emerson

31 Brooks Dr / Braintree, MA 02184

Tel: (603)491-6666

Fax: (781) 843-3849

Email: demerson@symmons.com

www.symmons.com

Tech Support: (800) SYMMONS / (781) 848-2250

After Hours Emergency Contact:

(800) SYMMONS / (781) 848-2250

Associate Member PHCC of Maine

TSS ASSOCIATES, INC.

Manufacturer's Representative

Axiom, Smith CI Boilers, Argo Baseboard, Bosch,
Buderus, Aquecoil, Thermo Pride, Spirit Series,
Beckett, Turbonics, Intellihot

Steven Grady

433 New Karner Road

Albany, NY 12205

Tel: (518)621-7283

steve@tssassociatesinc.com

www.tssassociatesinc.com

Associate Member PHCC of Maine

URELL, INC.

Manufacturer's Representative

American Standard, A.O. Smith, Burnham
Commercial, Granby Tanks, Circuit Solver, Grohe,
Grundfos, Spirotherm, State Water Heater, Uponor,
Ward Manufacturing, Wardflex, U.S. Boiler, Zoeller,
Thermal Solutions, American Water Heater, Fabtek

Bob Thompson, Dillon Douglass, Brad Lunt

86 Coolidge Ave / PO Box 321

Watertown, MA 02471

Tel: (617) 923-9500

Email: info@urell.com

www.urell.com

Associate Member PHCC of Maine

VIEGA

Manufacturer

ProPress; MegaPress (SST, Gas, FKM); ProPress
XL-C; ProRadiant; Pureflow; Viega heating and
cooling systems

Tom Keefe

17 Elaine Dr / Nashua, NH 03062

Tel: (603) 494-5723

Email: tom.keefe@viega.us www.viega.net

Tech Support: (877) 843-4262

techsupport@viega.us

After Hours Emergency Contact: Inside Sales

(800) 976-9819

Associate Member PHCC of Maine

VISSMANN MANUFACTURING CO.

Manufacturer

Oil/Gas-Fired Heating Boilers, Gas-Fired Heating
Boilers, Boiler and Heating System Controls, Indirect-
Fired Domestic Hot Water Storage Tanks, Hydronic
Heating Accessories, Solar Systems, Gas- Fired
Condensing Boilers, Commercial Boiler and Heating
System Controls

Jim Bolduc

Tel: (207) 532-8500

Fax: (401) 732-0590

Email: bolj@viessmann.com

www.viessmann-us.com

Tech Support: (888) 484-8643

After Hours Emergency Contact:

Jim Bolduc (207) 532-8500

Associate Member PHCC of Maine

WALTER F. MORRIS CO.

Manufacturer's Representative

3M, Aquamotion, AtlasFiltri, Bock, Canplas, Central
Brass, Conex Banninger, Airco, Olsen, Eemax,
Encore, Endura, Fluidmaster, IPEX, Lux, North
Star, Nvent Caddy, NTI, Olympia, Peerless Boilers,
Pentair, Pioneer, RDT Reliance, Floodmaster,
Rheem, RUUD, Saniflo, Sioux Chief, Superior Water
Conditioners, Watco, Woodford

Barry Guertin

77 Green St / Foxboro, MA 02035

Tel: (800) 888-1922

Fax: (800) 888-1942

Email: bguertin@morrismERCHANTS.com

www.morrismERCHANTS.com

Associate Member PHCC of Maine

WARWICK HANGER

Manufacturer

Prime manufacturer of Pipehanger and supports

Michael, Ellery, President

34 Canal St / Westerly, RI 02891

Tel: (401) 596-8062

Email: mellery@warwickhanger.com

WINSUPPLY OF PORTLAND

Wholesaler

A.O Smith, Baxi, Viessmann, Biasi, Smith Boilers,
American Standard, Gerber, Oasis, Viega, ProPress,
Eternal Hybrid, Haydon, Mansfield, Moen, Rinnia,
Amtrol, Super Stor, Wilo, Caleffi, Taco, Honeywell,
Gastite

Nathan Bassett, Outside Sales

177 Cash St / South Portland, ME 04106

Tel: (207) 773-9466 / (866) 378-9466

Fax (207) 773-1533

nbassett@winsupplyinc.com

www.winsupplyofportland.com

Associate Member PHCC of Maine



BRANCH DIRECTORY:

HAMPDEN, ME BRANCH
phone: 207.945.6405

PORTLAND, ME BRANCH
phone: 207.874.9500

MANCHESTER, NH BRANCH
phone: 603.623.1215

MEREDITH, NH BRANCH
phone: 603.259.1980

WILLISTON, VT BRANCH
phone: 802.863.0355

WILMINGTON, MA BRANCH
(CORPORATE HQ)
phone: 800.648.8310

BUSINESS SOLUTIONS:



Homans.com
Streamline your business
Place orders online, check inventory, make payments and so much more on homans.com



Maximize your sales opportunities
oncallair.com/homans

Housecall Pro
Help grow your revenue
promos.homans.com/housecall-pro/



Homans Mobile App
Save Time on-the-go
Bring your Homans account wherever you go with the Homans Mobile App



Finance remotley with flexibility
creditforcomfort.com



Reduce service costs
alertlabs.com/pages/contractors

shop online 24/7 - homans.com or Homans Mobile App

Maine PHCC Scholarships



Scholarships with Simple Application to bring new people into the trade.

Maine PHCC has updated their scholarship eligibility for all Members and Associate Members and their employees.

To build workforce and help to bring new people into the trade it was decided that the scholarships would be given to unlicensed applicants or apprentices. Anyone with a journeyman licensee or higher would not be eligible.

- Maine PHCC Scholarship - Up to \$500 per member per year.
- MEMA has generously offered to charge the membership rate for anyone receiving a scholarship.
- \$1,125 reimbursement from the State of Maine for apprentices enrolled in Plumbing 101 of the PHCC Academy e-learning after working six months.

Courses or Programs for plumbing, oil, gas, hvac offered through PHCC, MEMA, Community Colleges or NTI.

PHCC National Auxilliary Scholarships

The PHCC—National Auxiliary awards more than \$40,000 in scholarships each year, with more than 20 individual scholarships awarded in a typical year. Applicants must secure a recommendation from a PHCC—National Auxiliary member. All submissions must be completed by August 15 for classes beginning in the fall. <https://www.phccnationalauxiliary.org/scholarships>

***Maine PHCC is a sponsor of
Maine Blue Collar Foundation, www.mainebluecollar.com***

More scholarship information is available on the next page.

2024 Scholarship Program Open for Applications!

***This year the PHCC Educational Foundation has approximately
\$140,000 up for grabs through 56 scholarships.***

Get Help With Training Costs for New Apprentices

Need help with recruiting and covering the costs of training new apprentices? The Foundation's Scholarship program can help!

Who is Eligible to Apply?

- Plumbing or HVAC apprentices who are working full time for a PHCC contractor member.
- Trade school or community college students taking plumbing or HVAC classes.
- College students pursuing majors directly related to the plumbing-heating-cooling industry.
- A max of 4 apprentices per company can win, so only have your top contenders apply.

How Does Someone Apply?

- Visit phccfoundation.org/scholarships
- Gather required submission materials (letters of recommendation and background info).
- Complete the online application form, uploading the required documents.

When is the Deadline and When Are Winners Selected?

- Applications and all required supporting materials are due by May 1st.
- The Foundation Scholarship committee reviews applications over the summer. Winners are notified in late July and award checks are mailed directly to schools in August.

Our scholarships are possible thanks to contractor contributions and our generous sponsors.

American Standard[®]
WATER HEATERS

Tomorrow's Solutions Today.

HYBRID HEAT PUMP WATER HEATER

PREMIUM EFFICIENCY / PERFORMANCE

- Up to 4.01 UEF
- Up to 87 gallon FHR

LEAKAGE DETECTION FUNCTION

- Integrated leak sensor
- App notifications
- Optional shut-off valve

SMART CONNECTIVITY

- Wi-Fi Connectivity
- Comfort Link mobile app

TOTAL COMFORT AND FULL CONTROL

- I-Memory habit-learning algorithm
- Customizable working modes

PEACE OF MIND

- Dual cathodic protection with 1 powered and 1 magnesium anode
- 10-year tank and parts warranty

 **EMERSON SWAN**
A Swan Group Company

Model Numbers:

ASHPWH-50
50 Gallons

ASHPWH-65
65 Gallons





ASHPWH-80
80 Gallons



WE MEAN BUSINESS



JOIN PHCC TODAY!

 [phccnatl](#)
 [@PHCCNational](#)
 [in/phccnational](#)
 [@MainePHCC](#)

Maine PHCC
www.maine-phcc.com
(207) 829-5055



ADAPTABILITY



ULTRA FLEXIBLE TANKLESS TECHNOLOGY.

As a plumbing pro, you're not just in the field, you're on the clock... so every minute matters. That's why our new Adapt™ tankless water heater conforms to your exact needs with 2" or 3" venting, ½" or ¾" gas line, NG or LP hookup, and versatile indoor/outdoor installation.

LESS INVENTORY. FEWER TRIPS. MORE SAVINGS.

And the perks don't stop there. This cutting-edge tech has an integrated recirculation pump for hot water on demand, X3® Scale Prevention Technology, and Wi-Fi capability. For a universal tankless solution, nothing flexes like the State Adapt. The ultimate hot water toolkit.

ADAPT... GO CONFIGURE

 **state**
WATER HEATERS
statewaterheaters.com

URELL
Proudly Representing State
Water Heaters in New England
www.urell.com

CALENDAR YEAR 2024

JANUARY							FEBRUARY							MARCH						
S	M	T	W	T	F	S	S	M	T	W	T	F	S	S	M	T	W	T	F	S
	1	2	3	4	5	6					1	2	3						1	2
7	8	9	10	11	12	13	4	5	6	7	8	9	10	3	4	5	6	7	8	9
14	15	16	17	18	19	20	11	12	13	14	15	16	17	10	11	12	13	14	15	16
21	22	23	24	25	26	27	18	19	20	21	22	23	24	17	18	19	20	21	22	23
28	29	30	31				25	26	27	28	29			24	25	26	27	28	29	30
														31						

APRIL							MAY							JUNE						
S	M	T	W	T	F	S	S	M	T	W	T	F	S	S	M	T	W	T	F	S
	1	2	3	4	5	6				1	2	3	4							1
7	8	9	10	11	12	13	5	6	7	8	9	10	11	2	3	4	5	6	7	8
14	15	16	17	18	19	20	12	13	14	15	16	17	18	9	10	11	12	13	14	15
21	22	23	24	25	26	27	19	20	21	22	23	24	25	16	17	18	19	20	21	22
28	29	30					26	27	28	29	30	31		23	24	25	26	27	28	29
														30						

JULY							AUGUST							SEPTEMBER						
S	M	T	W	T	F	S	S	M	T	W	T	F	S	S	M	T	W	T	F	S
	1	2	3	4	5	6					1	2	3	1	2	3	4	5	6	7
7	8	9	10	11	12	13	4	5	6	7	8	9	10	8	9	10	11	12	13	14
14	15	16	17	18	19	20	11	12	13	14	15	16	17	15	16	17	18	19	20	21
21	22	23	24	25	26	27	18	19	20	21	22	23	24	22	23	24	25	26	27	28
28	29	30	31				25	26	27	28	29	30	31	29	30					

OCTOBER							NOVEMBER							DECEMBER							
S	M	T	W	T	F	S	S	M	T	W	T	F	S	S	M	T	W	T	F	S	
			1	2	3	4	5						1	2	1	2	3	4	5	6	7
6	7	8	9	10	11	12	3	4	5	6	7	8	9	8	9	10	11	12	13	14	
13	14	15	16	17	18	19	10	11	12	13	14	15	16	15	16	17	18	19	20	21	
20	21	22	23	24	25	26	17	18	19	20	21	22	23	22	23	24	25	26	27	28	
27	28	29	30	31			24	25	26	27	28	29	30	29	30	31					

HOLIDAYS & OBSERVANCES

Jan 1 New Year's Day	Apr 1 Easter Monday	Sep 2 Labor Day
Jan 15 Martin Luther King Day	May 12 Mother's Day	Oct 14 Columbus Day
Feb 19 Presidents' Day	May 27 Memorial Day	Nov 11 Veterans Day
Mar 29 Good Friday	Jun 16 Father's Day	Nov 28 Thanksgiving Day
Mar 31 Easter Sunday	Jul 4 Independence Day	Dec 25 Christmas Day

CALENDAR YEAR 2025

JANUARY							FEBRUARY							MARCH						
S	M	T	W	T	F	S	S	M	T	W	T	F	S	S	M	T	W	T	F	S
			1	2	3	4						1							1	
5	6	7	8	9	10	11	2	3	4	5	6	7	8	2	3	4	5	6	7	8
12	13	14	15	16	17	18	9	10	11	12	13	14	15	9	10	11	12	13	14	15
19	20	21	22	23	24	25	16	17	18	19	20	21	22	16	17	18	19	20	21	22
26	27	28	29	30	31	23	24	25	26	27	28	23	24	25	26	27	28	29		
													30	31						

APRIL							MAY							JUNE							
S	M	T	W	T	F	S	S	M	T	W	T	F	S	S	M	T	W	T	F	S	
			1	2	3	4	5					1	2	3	1	2	3	4	5	6	7
6	7	8	9	10	11	12	4	5	6	7	8	9	10	8	9	10	11	12	13	14	
13	14	15	16	17	18	19	11	12	13	14	15	16	17	15	16	17	18	19	20	21	
20	21	22	23	24	25	26	18	19	20	21	22	23	24	22	23	24	25	26	27	28	
27	28	29	30	25	26	27	28	29	30	31	29	30									

JULY							AUGUST							SEPTEMBER						
S	M	T	W	T	F	S	S	M	T	W	T	F	S	S	M	T	W	T	F	S
			1	2	3	4	5						1	2	1	2	3	4	5	6
6	7	8	9	10	11	12	3	4	5	6	7	8	9	7	8	9	10	11	12	13
13	14	15	16	17	18	19	10	11	12	13	14	15	16	14	15	16	17	18	19	20
20	21	22	23	24	25	26	17	18	19	20	21	22	23	21	22	23	24	25	26	27
27	28	29	30	31	24	25	26	27	28	29	30	28	29	30						
							31													

OCTOBER							NOVEMBER							DECEMBER						
S	M	T	W	T	F	S	S	M	T	W	T	F	S	S	M	T	W	T	F	S
			1	2	3	4						1	1	2	3	4	5	6		
5	6	7	8	9	10	11	2	3	4	5	6	7	8	7	8	9	10	11	12	13
12	13	14	15	16	17	18	9	10	11	12	13	14	15	14	15	16	17	18	19	20
19	20	21	22	23	24	25	16	17	18	19	20	21	22	21	22	23	24	25	26	27
26	27	28	29	30	31	23	24	25	26	27	28	29	28	29	30	31				
							30													

HOLIDAYS & OBSERVANCES

Jan 1 New Year's Day	Apr 20 Easter Monday	Sep 1 Labor Day
Jan 20 Martin Luther King Day	May 11 Mother's Day	Oct 13 Columbus Day
Feb 17 Presidents' Day	May 26 Memorial Day	Nov 11 Veterans Day
Apr 18 Good Friday	Jun 15 Father's Day	Nov 27 Thanksgiving Day
Apr 20 Easter Sunday	Jul 4 Independence Day	Dec 25 Christmas Day

MAINE



**PLUMBING-HEATING-COOLING
CONTRACTORS ASSOCIATION®**
Best People. Best Practices.™

Introductory Membership Special

2024 Membership Application

Simply fill out and return this form to:

Maine PHCC 69 Rock Ridge Run, Cumberland, ME 04021

For more information please call (207) 829-5055 or visit

www.maine-phcc.com (Maine) or www.phccweb.org (National)

Name: _____

Company: _____

Address: _____ Zip Code: _____

Telephone: _____ Fax: _____ Email: _____

Mail Check Or charge to: American Express Visa Mastercard **Amount \$362.50**

Card Number: _____ Exp. Date: _____ CSV Code _____

Signature: _____ Date: _____

Please check the areas of most interest to you:

- | | |
|--|--|
| <input type="checkbox"/> Industry Networking | <input type="checkbox"/> Industry News |
| <input type="checkbox"/> Workforce Development | <input type="checkbox"/> Legislation |
| <input type="checkbox"/> Education | <input type="checkbox"/> Benefits |

I understand that by providing my mailing address, email address, telephone number and fax number, I consent to receive communication sent by or on behalf of the Plumbing-Heating-Cooling Contractors via regular mail, email, telephone or fax. I understand that the Plumbing-Heating-Cooling Contractors Association will not share my address, e-mail, telephone or fax numbers with other organizations.

Contractor Dues \$758

Associate Member Dues \$300

New Members only \$350

Join now for a 50% reduction of the first year dues and a 25% reduction for the second year.

Includes State and National dues and benefits.

AUTOMAG™

The Automag Universal RI Zone valve is a cost-effective design that can replace existing zone valves from other manufacturers.

Automag Zone Valves normally open valve allows gravity circulation if power fails, with slow closure to eliminate water hammer.

Powered with 24 VAC Transformer Power Supply, and available in ¾" or 1" sweat connection or Press Fittings



Automag Universal Replacement Zone Valve

Made in
the USA



Represented by:
JOHN STACK SALES COMPANY
www.stacksales.com



Proud to support the Maine
PHCC Membership
1-800-466-4328



THE RIGHT PRODUCTS. THE RIGHT PEOPLE.
RIGHT AROUND THE CORNER.

 **FERGUSON**®

At Ferguson, nobody expects more from us than we do. And why should they? We're the ones who set the bar. Who expect more than the industry standard. From the warehouse to the job site, whatever it takes, we'll take you there.

EQUIPMENT | REPAIR PARTS | HYDRONICS | RADIANT HEAT | PLUMBING PARTS & SUPPLIES

Portland
(207) 773-4755

Manchester
(603) 669-8100

Nashua
(603) 589-7580

Bath
(207) 443-5592

Windham
(207) 892-0290

Portsmouth
(603) 436-3550

S.G. Torrice HVAC

Westbrook
(207) 560-6870

Portsmouth
(603) 373-6951

Manchester
(603) 945-1490

Hudson
(800) 335-4822